

GOODWE



User Manual

Hybrid Inverter
ET Series
(40-50kW)

Copyright © GoodWe Technologies Co.,Ltd. 2023. All rights reserved.

No part of this manual can be reproduced or transmitted to the public platform in any form or by any means without the prior written authorization of GoodWe Technologies Co.,Ltd.

Trademarks

GOODWE and other GoodWe trademarks are trademarks of GoodWe Technologies Co.,Ltd. All other trademarks or registered trademarks mentioned in this manual are owned by the company.

NOTICE

The information in this user manual is subject to change due to product updates or other reasons. This guide cannot replace the product labels or the safety precautions in the user manual unless otherwise specified. All descriptions here are for guidance only.

CONTENT

- 1 About This Manual 1**
 - 1.1 Applicable Model1
 - 1.2 Target Audience1
 - 1.3 Symbol Definition1
- 2 Safety Precaution 2**
 - 2.1 General Safety2
 - 2.2 PV String Safety2
 - 2.3 Inverter Safety3
 - 2.4 Battery Safety4
 - 2.5 Personnel Requirements4
 - 2.6 EU Declaration of Conformity4
- 3 Product Introduction 5**
 - 3.1 Product Overview5
 - 3.2 Application Scenarios6
 - 3.3 Working Mode10
 - 3.3.1 System working mode10
 - 3.3.2 Inverter operation mode16
 - 3.4 Features18
 - 3.5 Appearance22
 - 3.5.1 Parts22
 - 3.5.2 Dimension24
 - 3.5.3 Indicator Description24
 - 3.5.4 Nameplate25
- 4 Check and Storage26**
 - 4.1 Check Before Receiving26
 - 4.2 Storage26
 - 4.3 Deliverables27
- 5 Installation28**
 - 5.1 Installation Requirements28
 - 5.2 Inverter Installation31
 - 5.2.1 Moving the Inverter31
 - 5.2.2 Installing the Inverter31
- 6 Electrical Connection33**
 - 6.1 Safety Precaution33
 - 6.2 Cable Requirements34
 - 6.3 Wiring Diagram35
 - 6.4 Connecting the PE cable37

6.5	Connecting the DC Input Cable(PV)	37
6.6	Connecting the battery cable	39
6.7	Connecting the AC Cable	41
6.8	Communication	43
6.8.1	Connecting the Communication Cable.....	47
6.8.2	(Optional) Connecting the STS/ BMS/ METER communication cable	49
6.9	Installing the Communication Module	50
7	Equipment Commissioning	51
7.1	Check Before Power ON.....	51
7.2	Power On/Off.....	51
8	System Commissioning.....	53
8.1	Inverter Indicators.....	53
8.2	Setting Inverter Parameters via SolarGo App	54
8.3	Monitoring via SEMS Portal	55
9	Maintenance	56
9.1	Power OFF the Inverter	56
9.2	Removing the Inverter	57
9.3	Disposing of the Inverter	57
9.4	Troubleshooting.....	57
9.5	Routine Maintenance.....	67
10	Technical Parameters.....	68

1 About This Manual

This manual describes the product information, installation, electrical connection, commissioning, troubleshooting and maintenance. Read through this manual before installing and operating the product. All the installers and users have to be familiar with the product features, functions, and safety precautions. This manual is subject to update without notice. For more product details and latest documents, visit <https://en.goodwe.com>.

1.1 Applicable Model

This manual applies to the listed hybrid inverters below (ET for short):



- GW40K-ET-10
- GW50K-ET-10

1.2 Target Audience

This manual applies to trained and knowledgeable technical professionals only. The technical personnel has to be familiar with the product, local standards, and electric systems.

1.3 Symbol Definition

Different levels of warning messages in this manual are defined as follows:

 DANGER
Indicates a high-level hazard that, if not avoided, will result in death or serious injury.
 WARNING
Indicates a medium-level hazard that, if not avoided, could result in death or serious injury.
 CAUTION
Indicates a low-level hazard that, if not avoided, could result in minor or moderate injury.
NOTICE
Highlights key information and supplements the texts. Or some skills and methods to solve product-related problems to save time.

2 Safety Precaution

Please strictly follow these safety instructions in the user manual during the operation.

NOTICE

The inverters are designed and tested to strictly comply with related safety rules. Read and follow all the safety instructions and cautions before any operations. Improper operation might cause personal injury or property damage as the inverters are electrical equipment.

2.1 General Safety

NOTICE

- The information in this user manual is subject to change due to product updates or other reasons. This guide cannot replace the product labels or the safety precautions in the user manual unless otherwise specified. All descriptions here are for guidance only.
- Before installations, read through the user manual to learn about the product and the precautions.
- All operations should be performed by trained and knowledgeable technicians who are familiar with local standards and safety regulations.
- Use insulating tools and wear personal protective equipment when operating the equipment to ensure personal safety. Wear anti-static gloves, clothes, and wrist strips when touching electronic devices to protect the inverter from damage.
- Strictly follow the installation, operation, and configuration instructions in this guide and user manual. The manufacturer shall not be liable for equipment damage or personal injury if you do not follow the instructions. For more warranty details, please visit <https://en.goodwe.com/warranty>.

2.2 PV String Safety

DANGER

Connect the DC cables using the delivered DC connectors and terminals.

WARNING

- Ensure the component frames and the bracket system are securely grounded.
- Ensure the DC cables are connected tightly, securely and correctly.
- Measure the DC cables using a multimeter to avoid reverse polarity connection. Also, the voltage should be under the permissible range.
- Do not connect one PV string to more than one inverter at the same time. Otherwise, it may cause damage to the inverter.









2.3 Inverter Safety

WARNING

- The voltage and frequency at the connecting point should meet the on-grid requirements.
- Additional protective devices like circuit breakers or fuses are recommended on the AC side. Specification of the protective device should be at least 1.25 times the rated AC output rated current.
- Copper-core cable is recommended for AC cable.
- When single overload protection occurs, the inverter can restart automatically; however, the restarting time will be extended if it happens several times. For a faster restarting, try it via APP.

DANGER

- Do not apply mechanical load to the terminals, otherwise the terminals can be damaged.
- All labels and warning marks should be visible after the installation. Do not cover, scrawl, or damage any label on the equipment.
- Warning labels on the inverter are as follows:

	<p>HIGH VOLTAGE HAZARD High voltage exists during the inverter's running. Disconnect all incoming power and turn off the product before working on it.</p>		<p>Delayed discharge. Wait 5 minutes after power off until the components are completely discharged.</p>
	<p>Read through the user manual before any operations.</p>		<p>Potential risks exist. Wear proper Personnel Protective Equipment before any operations.</p>
	<p>High-temperature hazard. Do not touch the product under operation to avoid being burnt.</p>		<p>Grounding point.</p>
	<p>CE Mark</p>		<p>Do not dispose of the inverter as household waste. Discard the product in compliance with local laws and regulations, or send it back to the manufacturer.</p>
	<p>RCM Mark.</p>	<p>-</p>	<p>-</p>

2.4 Battery Safety



WARNING

- The battery used with the inverter shall be approved by the inverter manufacturer. The approved battery list can be obtained through the official website.
- Before installations, read through the corresponding battery's user manual to learn about the product and the precautions. Strictly follow its requirements.
- If the battery discharged completely, please charge it in strict accordance with the corresponding model's user manual.
- Factors such as: temperature, humidity, weather conditions, etc. may limit the battery's current and affect its load.
- Contact after-sale service immediately if the battery is not able to be started. Otherwise, the battery might be damaged permanently.
- Measure the DC cable using the multimeter to avoid reverse polarity connection. Also, the voltage should be under the permissible range.
- Do not connect one battery group to several inverters at the same time. Otherwise, it may cause damage to the inverter.

2.5 Personnel Requirements

NOTICE

- Personnel who install or maintain the equipment must be strictly trained, learn about safety precautions and correct operations.
- Only qualified professionals or trained personnel are allowed to install, operate, maintain, and replace the equipment or parts.

2.6 EU Declaration of Conformity

GoodWe Technologies Co., Ltd. hereby declares that the inverter with wireless communication modules sold in the European market meets the requirements of the following directives:

- Radio Equipment Directive 2014/53/EU (RED)
- Restrictions of Hazardous Substances Directive 2011/65/EU and (EU) 2015/863 (RoHS)
- Waste Electrical and Electronic Equipment 2012/19/EU
- Registration, Evaluation, Authorization and Restriction of Chemicals (EC) No 1907/2006 (REACH)

You can download the EU Declaration of Conformity on <https://en.goodwe.com>.

GoodWe Technologies Co., Ltd. hereby declares that the inverter without wireless communication modules sold in the European market meets the requirements of the following directives:

- Electromagnetic compatibility Directive 2014/30/EU (EMC)
- Electrical Apparatus Low Voltage Directive 2014/35/EU (LVD)
- Restrictions of Hazardous Substances Directive 2011/65/EU and (EU) 2015/863 (RoHS)
- Waste Electrical and Electronic Equipment 2012/19/EU
- Registration, Evaluation, Authorization and Restriction of Chemicals (EC) No 1907/2006 (REACH)

You can download the EU Declaration of Conformity on <https://en.goodwe.com>.

3 Product Introduction

3.1 Product Overview

Intended usage

Inverters control and optimize the power in PV systems through an integrated energy management system. In the self consumption mode, the power generated in the PV system can be prioritized for load use, excess power can be stored in the battery, and when the battery is full, it can be fed to the grid, etc.

When the inverter is paired with STS, it supports generators and high power load such as heat pumps and high-power motors; the power of a single motor shall be $\leq 5.5\text{kVA}$.

Model Description

This manual applies to the listed inverters below:

- GW40K-ET-10
- GW50K-ET-10

GW40K-ET-10



No.	Referring to	
1	Brand Code	GW: GoodWe
2	Rated Power	<ul style="list-style-type: none"> • 40K: the rated power is 40 kW. • 50K: the rated power is 50 kW.
3	Series Code	ET: ET Series hybrid inverter
4	Version Code	10: First version inverter

Supported Grid Types

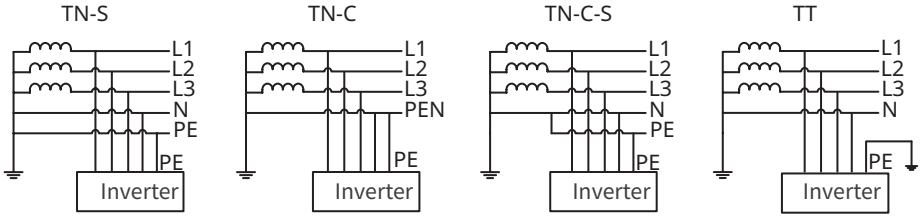

3.2 Application Scenarios

WARNING

- A STS static switch cabinet is needed to use the BACK-UP function of the inverter.
- The PV system is not suitable to connect equipment that relies on a stable power supply, such as medical equipment to sustain life. Ensure that no personal injury is occurred when the system is disconnected.
- Avoid loads with high starting current like high-power water pumps in the PV system. Otherwise, the off-grid output may fail due to excessive instantaneous power.
- BACK-UP is not recommended if the PV system is not configured with batteries. Otherwise, the risk in system power usage is beyond the equipment manufacturer's warranty scope.
- The inverter paired with STS has a UPS-level off-grid switching function, and the switching time is less than 20ms. Please ensure that the BACK-UP load capacity is less than the rated power of the inverter; otherwise, it may cause function failure when the grid is power off.
- Factors such as: temperature, humidity, weather conditions, etc. may limit the battery's current and affect its load.
- When single overload protection occurs, the inverter can restart automatically; however, the restarting time will be extended if it happens several times. For a faster restarting, try it via APP.
- Normal household loads can be supported when the inverter is in back-up mode. Accepted loads as below:
 - Inductive load: The power of a single device is ≤ 5.5 kVA, and multiple devices cannot be started at the same time.
 - Capacitive load: total power ≤ 0.66 times of the inverter's rated output power.

Scenarios without STS

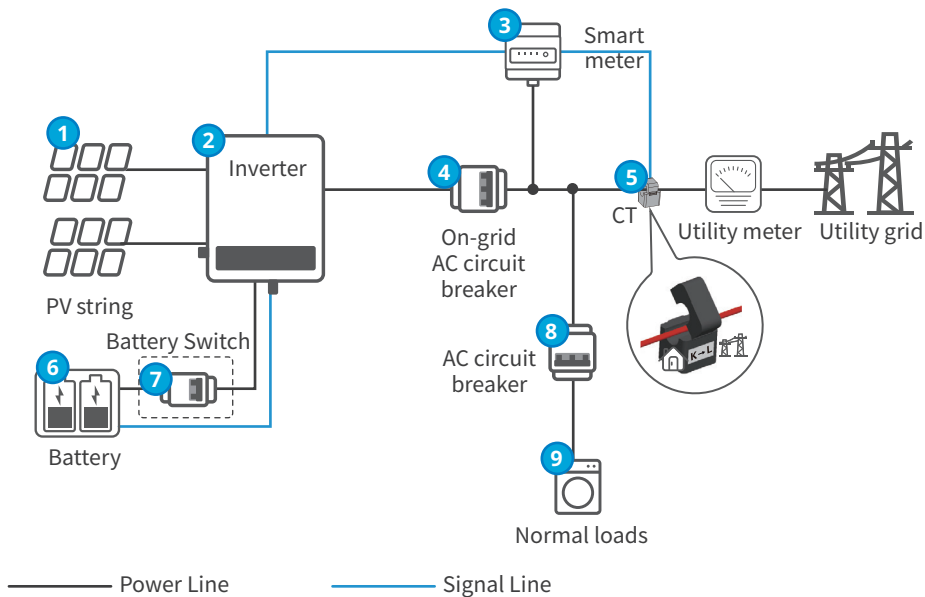

No.	Parts	Description
1	PV string	PV string is composed of series connected PV panels.
2	Inverter	Supports ET40-50kW series inverters.
3	Smart meter	Please use the GM330 or GM3000 smart meter shipped with the inverter.
4	On-grid AC circuit breaker	<ul style="list-style-type: none"> Please prepare AC circuit breaker by yourself. Recommended specifications: GW40K-ET-10: the nominal voltage is $\geq 400\text{Vac}$, the nominal current is $\geq 80\text{A}$ GW50K-ET-10: the nominal voltage is $\geq 400\text{Vac}$, the nominal current is $\geq 100\text{A}$
5	CT	<ul style="list-style-type: none"> When using the GM330 smart meter, please select a CT according to recommendation in the smart meter manual and set the CT ratio through SolarGo APP. When using the GM3000 smart meter, please use the CT delivered with the smart meter.
6	Battery	Select the battery model according to the inverter model and the approved battery list.

No.	Parts	Description
7	(Optional) Battery Switch	<ul style="list-style-type: none"> It must meet local regulatory requirements. AC breakers should be prepared by the customers. Recommended specifications: the nominal voltage is $\geq 1000\text{Vdc}$, the nominal current is $\geq 125\text{A}$
8	AC circuit breaker	Depend on the actual using load.
9	Normal loads	The load on the On-grid side can be connected according to actual needs.

Scenarios with STS

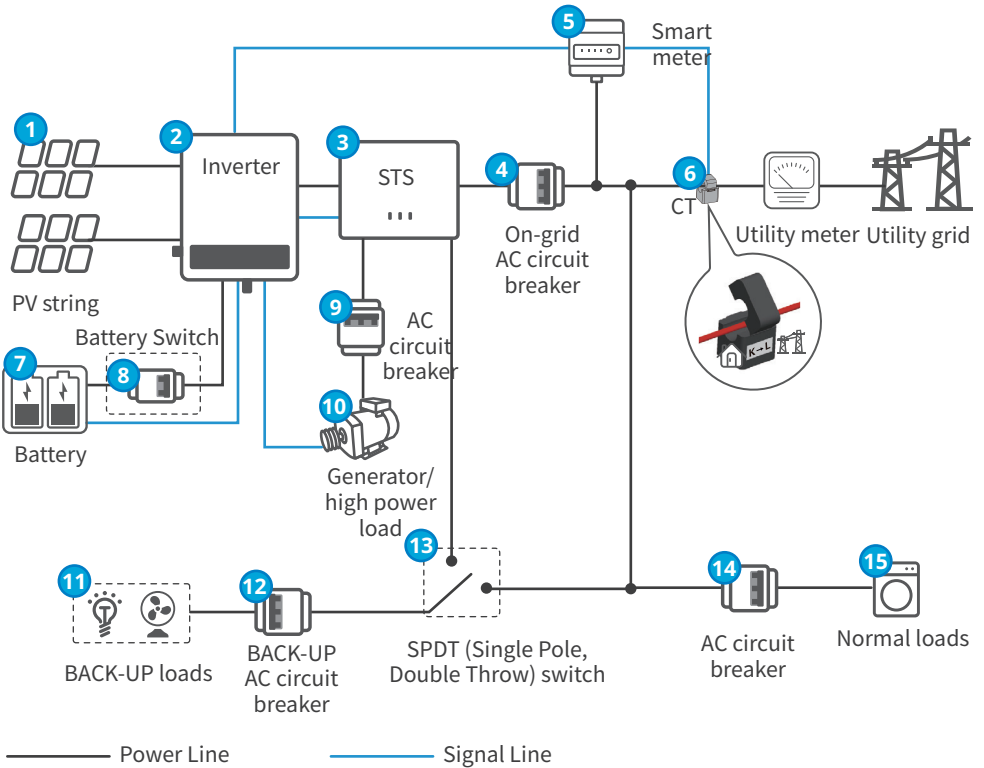

No.	Parts	Description
1	PV string	PV string is composed of series connected PV panels.
2	Inverter	Supports ET40-50kW series inverters.
3	STS	Supports STS series static transfer switches.
4	On-grid AC circuit breaker	<ul style="list-style-type: none"> Please prepare AC circuit breaker by yourself. Recommended specifications: <ul style="list-style-type: none"> GW40K-ET-10: the nominal voltage is $\geq 400\text{Vac}$, the nominal current is $\geq 80\text{A}$ GW50K-ET-10: the nominal voltage is $\geq 400\text{Vac}$, the nominal current is $\geq 100\text{A}$
5	Smart meter	Please use the GM330 or GM3000 smart meter shipped with the inverter.
6	CT	<ul style="list-style-type: none"> When using the GM330 smart meter, please select a CT according to recommendation in the smart meter manual and set the CT ratio through SolarGo APP. When using the GM3000 smart meter, please use the CT delivered with the smart meter.
7	Battery	Select the battery model according to the inverter model and the approved battery list.
8	(Optional) Battery Switch	<ul style="list-style-type: none"> It must meet local regulatory requirements. It should be prepared by the customers. Recommended specifications: <ul style="list-style-type: none"> the nominal voltage is $\geq 1000\text{Vdc}$, the nominal current is $\geq 125\text{A}$.
9	AC circuit breaker	Depend on the actual using load.
10	Generator/ high power load	<ul style="list-style-type: none"> It supports to connect generator or high power load. Generators and high power load cannot be connected to STS simultaneously. The inverter can control the start and stop of the generator connected to the STS or whether to supply power to high power load. The specifications for generators or high power load are: <ul style="list-style-type: none"> Generator: Voltage range 180-280V, frequency range 40-60Hz, power $\leq 55\text{kVA}$. High power load: The power of a single device needs to be $\leq 55\text{kVA}$.
11	BACK-UP loads	<ul style="list-style-type: none"> Supports connection of standby loads with a total power of no more than 50 kW, such as loads that require 24-hour power supply or other important loads. Connecting unbalanced loads. L1, L2, L3 of the inverter respectively connected to loads with different power.

No.	Parts	Description
12	BACK-UP AC circuit breaker	<ul style="list-style-type: none"> • Please prepare AC circuit breaker by yourself. • Recommended specifications: <ul style="list-style-type: none"> • GW40K-ET-10: the nominal voltage is $\geq 400\text{Vac}$, the nominal current is $\geq 80\text{A}$ • GW50K-ET-10: the nominal voltage is $\geq 400\text{Vac}$, the nominal current is $\geq 100\text{A}$.
13	(Optional) SPDT (Single Pole, Double Throw) switch	<ul style="list-style-type: none"> • It should be prepared by the customers. • To ensure that the BACK-UP loads can continue to function during STS power-off maintenance, it is recommended to install a SPDT switch. • Recommended specifications: <ul style="list-style-type: none"> • GW40K-ET-10: the nominal voltage is $\geq 400\text{Vac}$, the nominal current is $\geq 80\text{A}$ • GW50K-ET-10: the nominal voltage is $\geq 400\text{Vac}$, the nominal current is $\geq 100\text{A}$.
14	AC circuit breaker	Depend on the actual using load.
15	Normal loads	The load on the On-grid side can be connected according to actual needs.

3.3 Working Mode

3.3.1 System working mode

Self consumption mode

NOTICE

- For solar power, consider self consumption mode in priority: the excess power charges the battery in day time; the battery supplies power to the load when there is no solar power generated at night. This will improve the self consumption rate and saves electricity costs.
- It is suitable for areas with high electricity prices and little or no solar power generation subsidies.

• Day time:

- When the power generated in the PV system is sufficient, it will supply the loads in priority. And the excess power will charge the batteries first. The remaining power will be sold to the grid.
- When the power generated in the PV system is insufficient or no power is generated, the battery will supply the loads in priority. If the battery power is insufficient, then the load will be powered by the grid.

• Night:

If the battery power is sufficient, the load will be powered by the battery. If the battery power is not enough, the load will be powered by the grid.

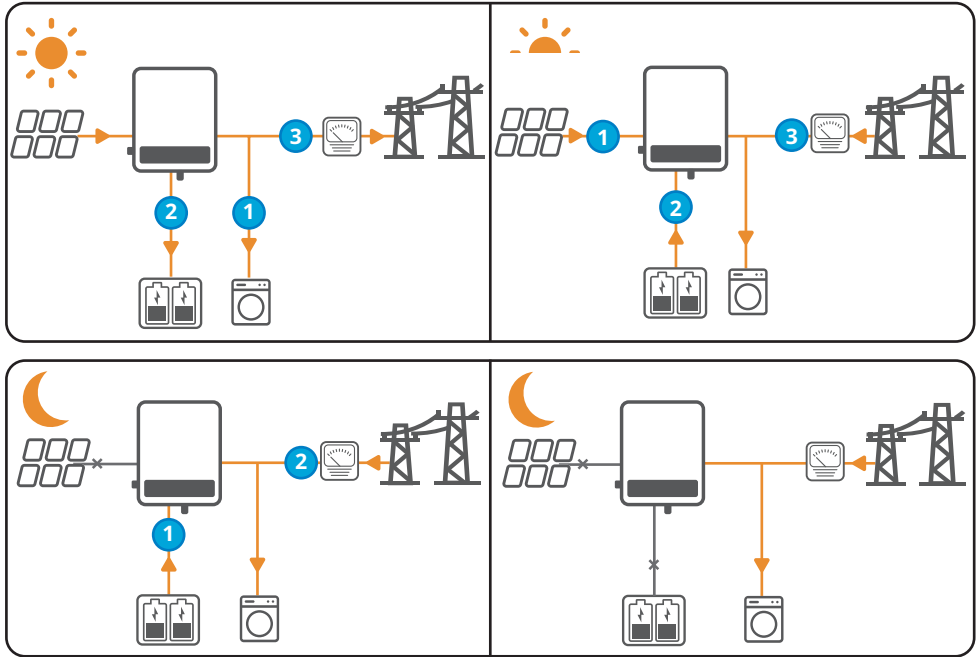

NOTICE

In the self consumption mode, when paired with STS, the battery can supply power to the BACK-UP loads when the grid is out of power.

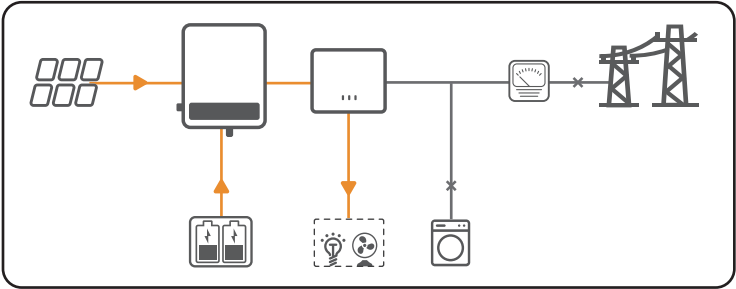

Economic mode

NOTICE

- Select Economic mode only when it meets the local laws and regulations, e.g., whether the grid is allowed to charge the battery. If not, do not use this mode.
- It is recommended to use economic mode in scenarios when the peak-valley electricity price varies a lot.

- When the electricity price is at its valley, set the time for the grid to charge the battery.
- When the electricity price is at its peak, the battery will power the load first, and the remaining power can be sold to the grid.

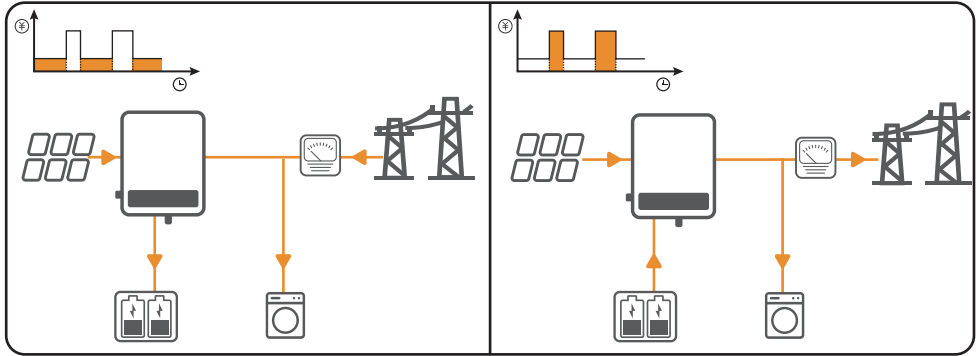

NOTICE

In economic mode, it can be used with STS to realize battery backup function.

- When received a power outage notification or during severe weather, the battery can be set to be charged before the grid outage.
- Batteries can be used to power loads during grid power outages.

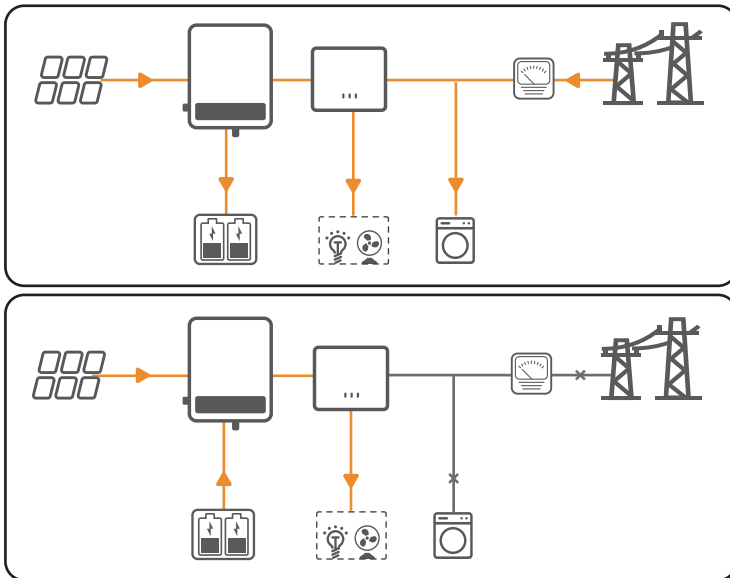

Back-up mode

NOTICE

- Backup function can be used with STS.
 - Different battery SOC values can be set for on-grid and off-grid condition under the backup mode. When the grid is disconnected, the inverter turns to off-grid mode to supply power to the load and to ensure that the BACK-UP loads are powered; when the grid is restored, the inverter switches to on-grid mode. When the battery SOC is below a set value, the inverter will charge the battery.
 - The purchase of electricity from the power grid to charge the battery must comply with local power grid laws and regulations.
 - It is recommended to be used when the grid is unstable.
- When the SOC of the battery is lower than the set value, the power generated by PV modules and purchased from the grid will charge the load and the battery.
 - When the grid is disconnected, if the PV power is insufficient for the load, the battery discharge will supplement the power to ensure that the Back-UP loads are powered.

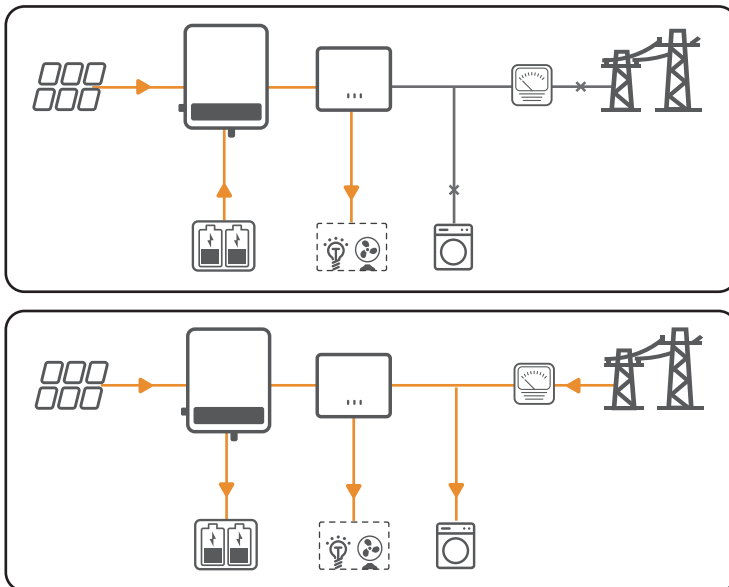

Peakshaving mode

NOTICE

Peak shaving mode is mainly applicable to industrial and commercial scenarios. When the total power consumption of the loads exceeds the peak shaving limit in short time, the battery discharges to reduce the power consumption exceeds the peak shaving limit.

- When the PV power generation and the electricity quota exceeds the load demand, the excess power can charge the battery.
- When the load demand exceeds the total amount of PV power generation and electricity quota, the battery discharges to supplement the excess power demand.

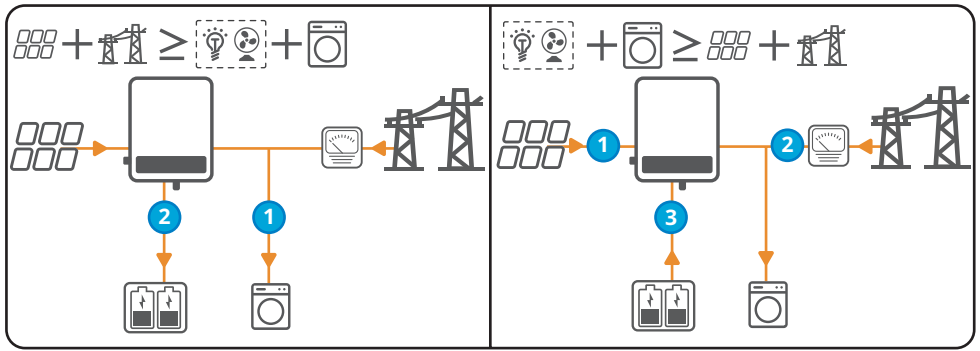

Delayed Charging Mode

NOTICE

- Delayed charging mode can avoid full charge of the battery early, which is a waste of energy when the PV Power generated is greater than the grid power export limit.
 - Applicable to areas with on-grid power output limit.
-
- Daytime: PV power generated prioritizes load demand. When the excess PV power is less than the power export limit, it will prioritize to sell electricity to the grid. When the excess PV generation exceeds the limit value, the excess power above the limit output power is used to charge the battery to prevent energy waste.
 - Night: If the battery power is sufficient, the load will be powered by the battery. If the battery power is not enough, the load will be powered by the grid.

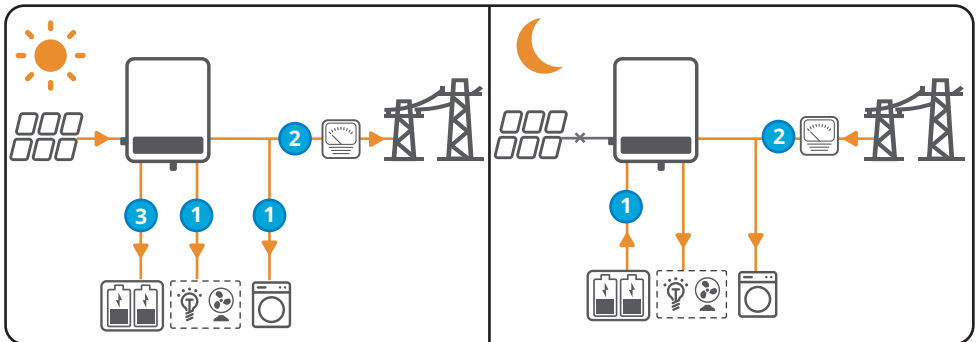

3.3.2 Inverter operation mode

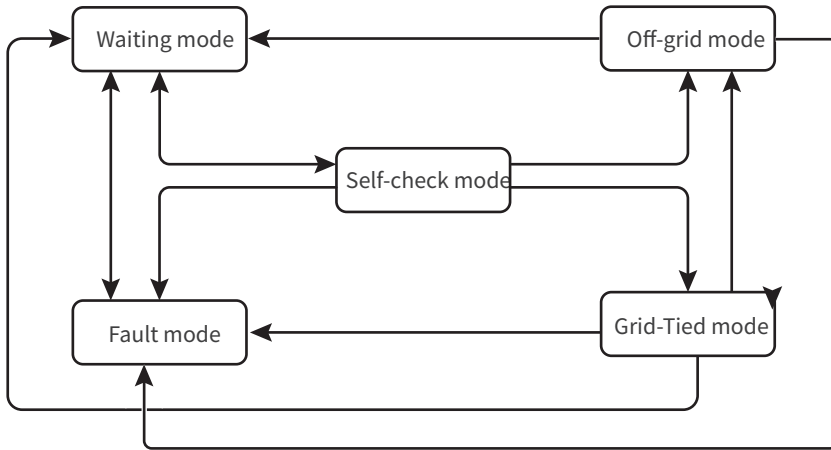

No.	Parts	Description
1	Waiting mode	Waiting stage after the inverter is powered on or when the grid is normal and the off grid output function is turned on, and the off grid output terminal is powered by the power grid. <ul style="list-style-type: none"> When the conditions are met, it enters the self-check mode. If there is a fault, the inverter enters the fault mode.
2	Self-check mode	Before the inverter starts up, it continuously performs self-check, initialization, etc. <ul style="list-style-type: none"> When the conditions are met, it enters the grid-tied mode, and the inverter starts on grid connection. If the grid is not detected, it enters the off-grid mode and the inverter runs off-grid; if the inverter has no off-grid function, it enters the wait mode. If the self-check is not passed, it enters the fault mode.
3	Grid-Tied mode	The inverter is grid-tied successfully. <ul style="list-style-type: none"> If the conditions do not meet grid-tied requirements, it enters the off-grid mode. If a fault is detected, it enters the fault mode. If the conditions do not meet grid-tied requirements and the off-grid output function is not turned on, it enters the fault mode.

No.	Parts	Description
4	Off-grid mode	<p>When the grid is powered off, the inverter switches to the off-grid mode and continues to supply power to the load via BACK-UP port.</p> <ul style="list-style-type: none">• If a fault is detected, it enters the fault mode.• If the conditions do not meet grid-tied requirements and the off-grid output function is not turned on, it enters the fault mode.• If the conditions meet grid-tied requirements and the off-grid output function is turned on, it enters the grid-tied mode.
5	Fault mode	<p>If a fault is detected, the inverter enters the fault mode. When the fault is cleared, it enters the wait mode.</p>

Off-grid mode can be used with STS.

3.4 Features

Power derating

For a safe operation or the compliance with local laws and regulation, the inverter will automatically reduce the output power when the operating environment is not ideal. The following are the factors that may occur power derating. Please try to avoid them when the inverter is working.

- Unfavorable environmental conditions, e.g., direct sunlight, high temperature, etc.
- Inverter's output power percentage has been set.
- Change of the voltage and frequency of the grid.
- Higher input voltage value.
- Higher input current value.

AFCI(Optional)

Reason to occur electric arcs

- Damaged connectors in PV or battery system.
- Wrong connected or broken cables.
- Aging of connectors and cables.

Method to detect electric arcs

- The inverter has an integrated AFCI function and meets the IEC 63027 standard.
- When the inverter detects an electric arc, users can find the time of the fault and the detailed phenomenon through SolarGo App.
- The inverter will shutdown for protection after triggering an AFCI alarm. After the alarm is cleared, the inverter will automatically reconnect to the grid for operation.
 - Automatic reconnection: If the inverter triggers AFCI alarm less than 5 times within 24 hours, each alarm will be automatically cleared after 5 minutes, and the inverter will reconnect to the grid for operation.
 - Manual reconnection: If the inverter triggers the 5th AFCI alarm within 24 hours, the alarm needs to be manually cleared before the inverter reconnect to the grid for operation. Please refer to the SolarGo App User Manual for detailed operation. Please refer to SolarGo App User Manual for detailed operations.

The AFCI function is disabled by default at the factory. To use it, please enable the "AFCI Detection" function through the "Advanced Settings" interface on the SolarGo App.

Model	Label	Description
GW40K-ET-10	F-I-AFPE-1-4/2-2	F: Full coverage I: Integrated AFPE: Detection and interruption capability provided 1: 1 monitored string per input port 4/2: 4/2 input ports per channel 2: 2 monitored channels
GW50K-ET-10	F-I-AFPE-1-4/4-2	F: Full coverage I: Integrated AFPE: Detection and interruption capability provided 1: 1 monitored string per input port 4/4: 4/4 input ports per channel 2: 2 monitored channels

Communication

The inverter is connected to the communication module, supporting the connection of 4G, WiFi/ LAN Kit-20 modules.

The inverter supports parameter setting in a short distance via Bluetooth connecting to SolarGo App. By connecting to the server via 4G, WiFi, or LAN, you can monitor the working status of the inverter and the running situations of the power plant, etc.

- 4G module (optional): supports mainstream operators like CMCC (China); Simpoint, T-moble, 1NCE (Europe) and Optus,Telstra (Australia).
- WiFi/LAN Kit-20Module:
 - WiFi communication: supports 2.4GHz frequency band. Set the router to 2.4GHz or 2.4GHz/5GHz coexistence mode. The maximum length of a WiFi network name is 40 bytes. ;
 - LAN communication supports connecting inverters to routers through network cables;
 - Bluetooth communication supports V4.2 BR/EDR and Bluetooth LE standard Class-1, class-2, and class-3 transmitters.

RSD(Optional)

- The inverter is equipped with a built-in RSD signal transmitter for communication with external module-level RSD smart shutdown devices. In case of an emergency, turn off DC switch of the inverter. The transmitter inside of the inverter is cut off, consequently to cut off the PV strings.
- If you need to install an external signal transmitter, please refer to the corresponding signal transmitter manual and RSD smart shutdown devices manual.

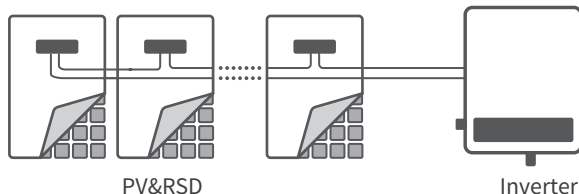

Unbalanced Three-phase Output

The inverter AC side supports unbalanced three-phase output, and the maximum output power per phase for different models is shown in the table below:

Model	Maximum output power per phase
GW40K-ET-10	14.66kW
GW50K-ET-10	18.33kW

Generator Control

Only when the inverter is used in conjunction with STS, it supports connection and control of the generator.

The inverter supports the connection of generator control signals and can control the start and stop of the generator connected to the GENERATOR port of the STS device. The generator control method is as follows:

- When the generator has no dry contact control port, the generator control mode of the inverter needs to be set to manual mode in the SolarGo App, and the generator should be manually controlled to start and stop.
 - Manual mode: When the switch is turned on, the generator operates; When the switch is turned off, the generator stops working. Please configure the relevant operating parameters via generator information or charging the battery through the generator.
- When the generator has a dry contact control port and is connected to the inverter, the generator control mode of the inverter needs to be set to manual mode or automatic mode in the SolarGo App.
 - Manual mode: When the switch is turned on, the generator operates; When the switch is turned off, the generator stops working or automatically stop working when it reaches the set operating time. Please configure the relevant operating parameters via generator information or charging the battery through the generator.
 - Automatic mode: The generator is prohibited from working during the set time period, while it operates during other time periods. Please configure the relevant operating parameters via generator information or charging the battery through the generator.

The generator control function is disabled by default. If you need to use it, please enable and set the generator control function through the SolarGo App.

Load Control

When the inverter is used with STS, it can control the load connected to the BACKUP LOAD or GENERATOR port of STS.

The inverter reserves a dry contact controlling port which supports connecting heat plump with SG Ready certificate and controllable load to enable/disable the load.

The load control methods are as follows:

- Dry contact mode: When the control mode is selected as ON, the load will be turned on; When the control mode is set to OFF, the load will be turned off.

- Time mode: in standard time mode, you can set the time for the load to be enabled or disabled and the load will automatically be enabled or disabled within the set time period; in intelligent time mode, when the remaining PV energy exceeds the nominal power of the load within the set time period, the load will be enabled.
- SOC mode: The inverter is equipped with a DO dry contact control port, which can control whether the load is turned off. In off-grid mode, the loads connected to the DO port can be turned off if the overload at the BACK-UP is detected or the battery SOC value is lower than the battery off-grid protection setting.

The load control function is disabled by default. If you need to use it, please enable and set the load control function through the SolarGo App.

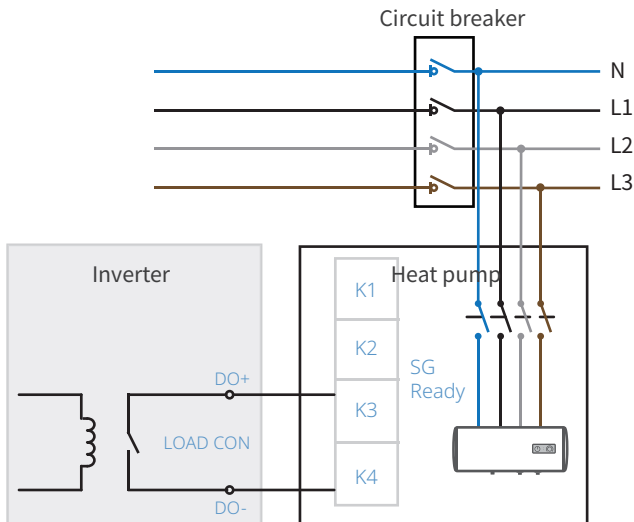

When SG Ready certified heat pumps and controllable loads are connected to the GENERATOR port of STS, the load control method is as follows:

- Dry contact mode: When the control mode is selected as ON, the load will be turned on; When the control mode is set to OFF, the load will be turned off.
- Time mode: in standard time mode, you can set the time for the load to be enabled or disabled and the load will automatically be enabled or disabled within the set time period; in intelligent time mode, when the remaining PV energy exceeds the nominal power of the load within the set time period, the load will be enabled.
- SOC mode: STS has a built-in switch that can control whether the load is turned off. In off grid mode, if an overload is detected at the BACK-UP port or the battery SOC value is lower than the battery off-grid protection value, all loads connected to the GENERATOR port will be turned off.

The load control function is disabled by default. If you need to use it, please enable and set the load control function through the SolarGo App.

3.5 Appearance

3.5.1 Parts

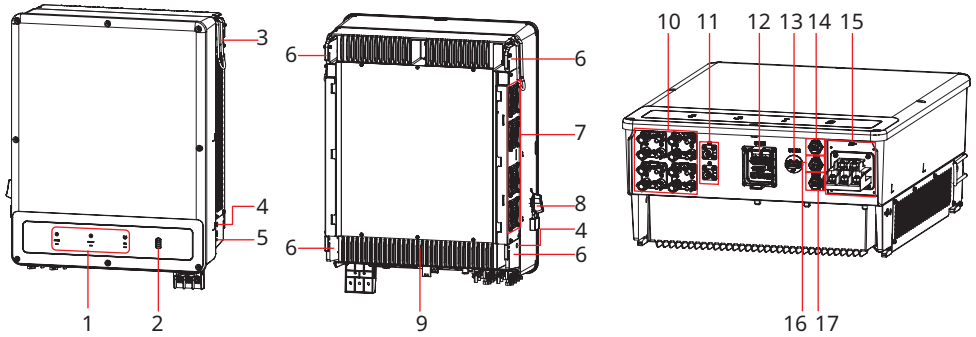

No.	Parts	Description
1	Indicator	Indicates working status of the inverter.
2	Battery SOC indicator	Indicates the SOC status of the battery
3	Handles	Used to move the Inverter
4	Handle installation holes	Used to install handles to move the Inverter
5	PE terminal	Connects the grounding cable of the inverter.
6	Mounting Plate	Used to install the inverter.
7	Fan	Uses for heat dissipation of the inverter.
8	DC Switch	Used to starts or stops PV input
9	Heat sink	Uses for heat dissipation of the inverter.
10	PV input terminal	Connect the PV module DC input cables. <ul style="list-style-type: none"> GW40K-ET-10: MPPT x 3 GW50K-ET-10: MPPT x 4
11	Battery DC input/output ports	Connect the battery input cables.
12	Communication port (COM1)	Connect communication cables and support RSD,DRED, Remote Shutdown, RCR, Load Control, Generator Control, Charging pile (reserved) communication.
13	Communication module port (COM2)	<ul style="list-style-type: none"> Used to connect communication modules, supporting connection to 4G, WiFi/LAN Kit-20 modules. Using a USB flash drive for system software upgrades.
14	STS communication port (STS)	Used to connect the STS communication cable.





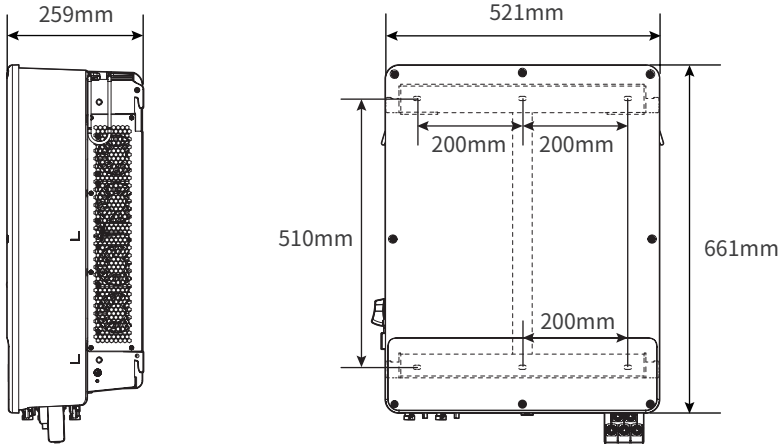











No.	Parts	Description
15	AC output port	Used to connect the AC Cable
16	Battery communication port (BMS)	Used to connect the BMS communication cable.
17	Meter communication port (METER)	Used to connect the meter communication cable.

3.5.2 Dimension







3.5.3 Indicator Description

Indicator Description

Indicator	Status	Description
 SYSTEM		The inverter is power on and in the standby mode.
		The inverter is starting up and in the self-check mode.
		The inverter is in normal operation under grid-tied or off-grid mode.
		BACK- UP output overload.
		A fault has occurred.
		The inverter is powered off.
 BACK-UP		The grid is abnormal, and the power supply to the BACK-UP port of the inverter is normal.
		The grid is normal, and the power supply to the BACK-UP port of the inverter is normal.
		The BACK-UP port has no power supply
 COM		The monitoring module of the inverter is resetting.
		The inverter fails to connect with the communication Termination.
		Communication fault between the communication Termination and Server.
		The monitoring of the inverter operates well.
		The monitoring module of the inverter has not been started yet.

Battery SOC indicator

Indicator	Description
	SOC=100%
	SOC=75%
	SOC=50%
	SOC=25%
	No battery connected

Indicator light blinking: for example, when the battery SOC is between 25% and 50%, the light at the 50% position blinks.

3.5.4 Nameplate

The nameplate is for reference only.

GOODWE

Product: Hybrid Inverter
Model : GW*-***-****

PV Input	UDCmax: ****Vd.c. UMPP: ****Vd.c. IoC,max: **/*A.d.c. ISC,PV: **/*A.d.c.
Battery	Ubatt: ****Vd.c., Li-Ion Ibatt,max (CID): **/*A.d.c.
On-grid	UAC,r: **/*A.d.c., Li-Ion fAC, r: **/*Hz PAC, r: ** kW IAC,max (to grid): **A.d.c. Sr (to grid): **kVA Smx (to grid): **kVA IAC,max (from grid): **A.d.c. Sr (from grid): **kV A Smx (from grid): **kV A
Back-up	UAC,r: **/*A.d.c. fAC, r: **/*Hz IAC,max: **A.d.c. Sr: **kV A Smx: **kV A

P.F.: **cap.,**ind. Toperating: ****~** °C
Non-isolated, IP**, Protective Class *, OVCDC**AC**



S/N:

GoodWe Technologies Co., Ltd.
 E-mail: service@goodwe.com
 No.90 Zijin Rd., New District, Suzhou, 215011, China S/N

GW trademark, product type, and product model

Technical parameters

Safety symbols and certification marks

Contact information and serial number

4 Check and Storage

4.1 Check Before Receiving

Check the following items before receiving the product.

1. Check the outer packing box for damage, such as holes, cracks, deformation, and other signs of equipment damage. Do not unpack the contents from the box and contact the supplier as soon as possible if any damage is found.
2. Check the inverter model. If the inverter model is not what you requested, do not unpack the product and contact the supplier.
3. Check the deliverables for correct model, complete contents, and intact appearance. Contact the supplier as soon as possible if any damage is found.

4.2 Storage

If the equipment is not to be installed or used immediately, please ensure that the storage environment meets the following requirements:

1. Do not unpack the outer package or throw the desiccant away.
2. Store the equipment in a clean place. Make sure the temperature and humidity are appropriate and no condensation.
3. The height and direction of the stacking inverters should follow the instructions on the packing box.
4. The inverters must be stacked with caution to prevent them from falling.
5. If the inverter has been long term stored, it should be checked by professionals before being put into use.

4.3 Deliverables

 **WARNING**

- Connect the DC cables with the delivered terminals. The manufacturer shall not be liable for the damage if other terminals are used.
- N:GW40K-ET-10 x 6; GW50K-ET-10 x 8.

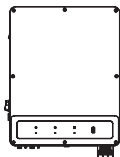

Inverter x 1

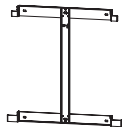

Mounting plate x 1

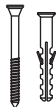

Expansion bolt x 6



M5 Screws x 2



PE terminal x 1



Tubular terminal x 25

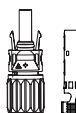

PV DC input terminal+ x N

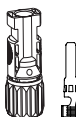

PV DC input terminal- x N

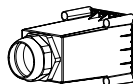

AC protective cover x 1



Communication module x 1

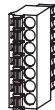

7Pin Communication terminal x 1



6Pin Communication terminal x 1



3Pin Communication terminal x 2



2Pin Communication terminal x 2



Battery connector x 2

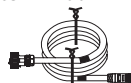

Meter communication cable x 1



AC OT terminal x 1



Insulating sleeve x 6



Meter and accessories x 1



PV unlocking tool x 1



Documents x 1

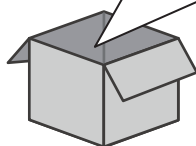

5 Installation

5.1 Installation Requirements

Installation Environment Requirements

1. Do not install the equipment in a place near flammable, explosive, or corrosive materials.
2. Do not install the equipment in a place that is easy to touch, especially within children's reach. High temperature exists when the equipment is working. Do not touch the surface to avoid burning.
3. Avoid the water pipes and cables buried in the wall when drilling holes.
4. Install the equipment in a sheltered place to avoid direct sunlight, rain, and snow. Build a sunshade if it is needed.
5. The place to install the equipment shall be well-ventilated for heat dissipation and large enough for operations.
6. The equipment with a high ingress protection rating can be installed indoors or outdoors. The temperature and humidity at the installation site should be within the appropriate range.
7. Install the equipment at a height that is convenient for operation and maintenance, ensure that the equipment's indicator lights, all labels are easy to view, and the wiring terminals are easy to operate.
8. The altitude to install the equipment shall be lower than the maximum working altitude 4000m.
9. Install the equipment away from electromagnetic interference. If there is any radio or wireless communication equipment below 30MHz near the equipment, you have to:
 - Add a multi-turn winding ferrite core at the DC input line or AC output line of the inverter, or add a low-pass EMI filter.
 - Install the inverter at least 30m far away from the wireless equipment.
10. The DC and communication cables between the battery and inverter should be less than 3 meters.



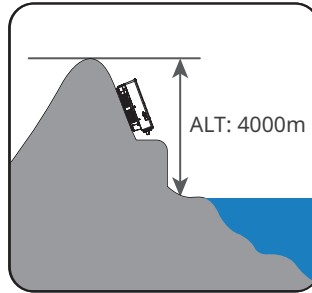
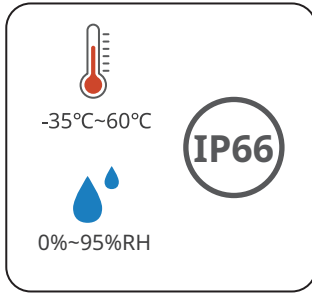
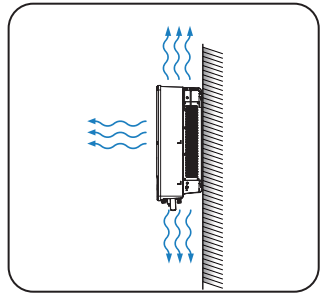
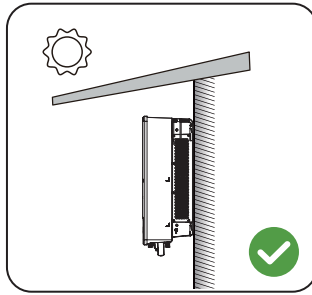
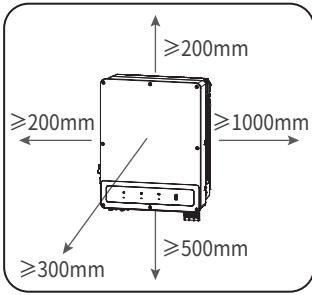

Mounting Support Requirements

- The mounting support shall be nonflammable and fireproof.
- Install the equipment on a surface that is solid enough to bear the inverter weight.
- Do not install the product on the support with poor sound insulation to avoid the noise bothering people nearby.





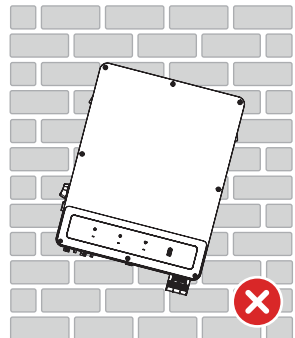
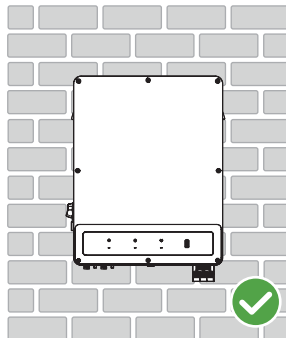
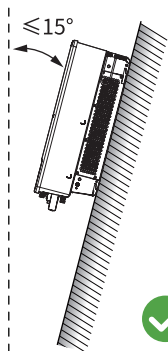







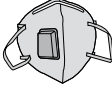
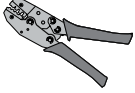

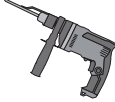

Installation Angle Requirements

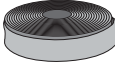
- Install the inverter vertically or at a maximum back tilt of 15 degrees.
- Do not install the inverter upside down, forward tilt, back forward tilt, or horizontally.

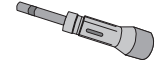

Installation Tool Requirements

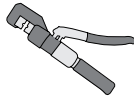
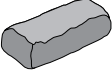
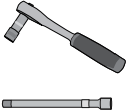
The following tools are recommended when installing the equipment. Use other auxiliary tools on site if necessary.

				
Goggles	Safety shoes	Safety gloves	Dust mask	Crimping pliers
				
Diagonal pliers	Wire stripper	Hammer drill	Heat gun	Vacuum cleaner
				 M4/M5 L > 150mm
Marker	Level	Heat shrink tube	Rubber hammer	Torque screwdriver
				
Multimeter	Cable tie	Cable cutter 18 inches	Hydraulic pliers YQK-70	Fire Barrier Putty
				
Socket wrench & Extension bar	Hex screws			

5.2 Inverter Installation

5.2.1 Moving the Inverter



CAUTION

- Operations such as transportation, shipment, installation and so on shall in compliance with the laws and regulations of the country or region where the inverter is located.
- Move the inverter to the site before installation. Follow the instructions below to avoid personal injury or equipment damage.
 1. Consider the weight of the equipment before moving it. Assign enough personnel to move the equipment to avoid personal injury.
 2. Wear safety gloves to avoid personal injury.
 3. Keep balance to avoid falling down when moving the equipment.

5.2.2 Installing the Inverter

NOTICE

- Avoid the water pipes and cables buried in the wall when drilling holes.
- Wear goggles and a dust mask to prevent the dust from being inhaled or contacting eyes when drilling holes.
- The DC switch lock (for Australia only) is provided by customers with an aperture of 8 mm.
- Please choose a suitable DC switch lock, otherwise it may not be installed.
- Make sure the inverter is firmly installed in case of falling down.

Step 1: Put the plate on the wall horizontally and mark positions for drilling holes.

Step 2: Drill holes to a depth of 80mm using the hammer drill. The diameter of the drill bit should be ≤ 8 mm.

Step 3: Use the expansion bolts to fix the plate on the wall.

Step 4: Open the inverter handles. If you need to install the additional handles, please contact the after-sales service center to obtain them.

Step 5: Install the inverter on the mounting plate.

Step 6: Secure the mounting plate and the inverter.

Step 7: (Optional) for Australia only Secure the DC switch with the DC switch lock, ensuring that the DC switch is "OFF" during installation.

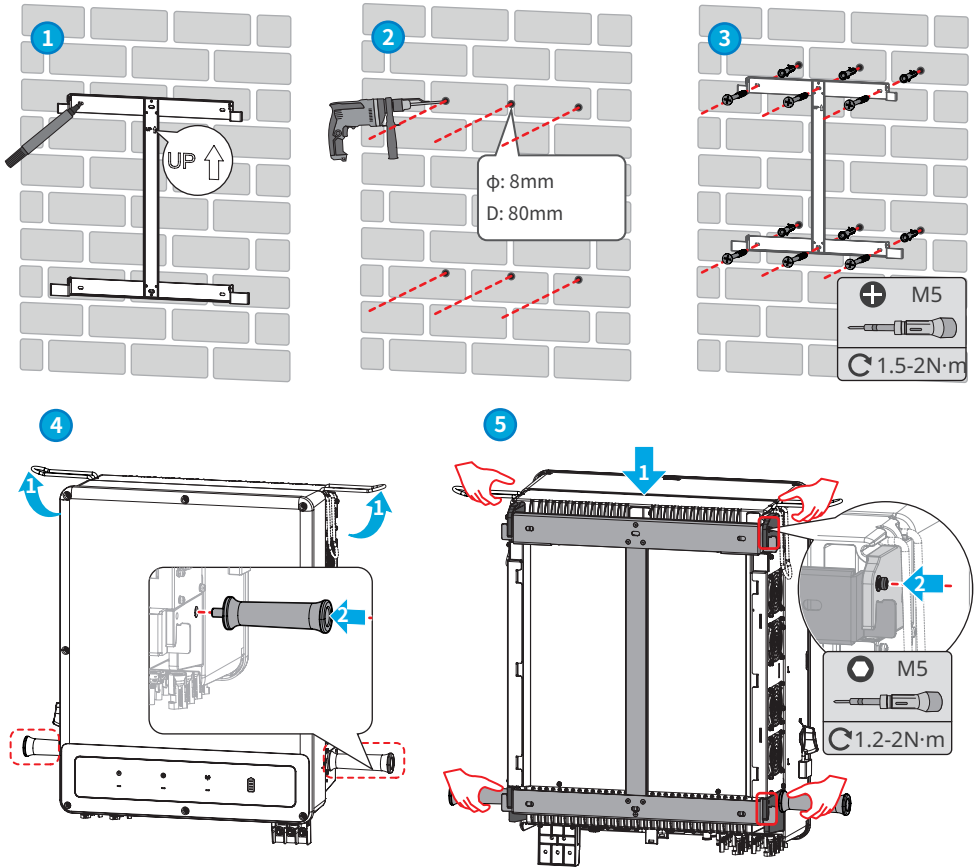

Contact the after-sales service center to obtain handles.

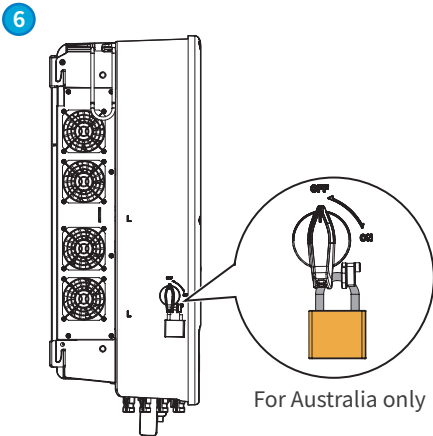

6 Electrical Connection

6.1 Safety Precaution

 **DANGER**

- Perform electrical connections in compliance with local laws and regulations. Including operations, cables, and component specifications.
- Disconnect the DC switch and the AC output switch of the inverter to power off the inverter before any electrical connections. Do not work with power on. Otherwise, an electric shock may occur.
- Tie the cables of the same type together, and place cables of different types apart. Do not place the cables entangled or crossed.
- If the tension is too large, the cable may be poorly connected. Reserve a certain length of the cable before connecting it to the inverter cable port.
- Make sure that the cable conductor is in full contact with the terminal and the cable insulation part is not crimped with the terminal when crimping the terminal. Otherwise, the inverter may not be able to work properly, or the connection may be unreliable during working, which may cause terminal block damage, etc.

NOTICE

- Wear personal protective equipment like safety shoes, safety gloves, and insulating gloves during electrical connections.
- All electrical connections should be performed by qualified professionals.
- Cable colors in this document are for reference only. The cable specifications shall meet local laws and regulations.

6.2 Cable Requirements

No.	Cable	Cable Requirements	Cable Specifications
1	Protective earthing cable	Outdoor copper core cable	Conductor cross-sectional area: 10mm ² -16mm ²
2	PV string DC cable		<ul style="list-style-type: none"> • Cable outer diameter: 4-5 mm • Conductor cross-sectional area: 4mm²-6mm²
3	Battery DC cable		<ul style="list-style-type: none"> • Cable outer diameter: 6.5-8.5mm • Conductor cross-sectional area: 25mm² • The inverter supports the connection of multiple types of batteries. When selecting the battery connection cable, it must be compatible with the battery cable requirements.
4	AC cable (AC~)		<ul style="list-style-type: none"> • Cable outer diameter: 18-38mm • Conductor cross-sectional area: 20mm²-25mm²
5	Battery communication cable (BMS)	Please use the BMS communication cable in the scope of delivery.	-
6	Meter communication cable (METER)	Please use the meter communication cable in the scope of delivery.	Cable length: 10 m
7	STS communication cable (STS)	Please use the inverter communication cable in the scope of delivery of STS.	-
8	(Reserved) Parallel communication cable	<ul style="list-style-type: none"> • RJ45 terminal • CAT 5E or higher level network cable. 	<ul style="list-style-type: none"> • Cable outer diameter: 5.5 mm • Conductor cross-sectional area: 0.2 mm²- 0.3 mm²
9	(Reserved) Charging station communication cable	<ul style="list-style-type: none"> • Only used when connecting a charging station. • Outdoor shielded twisted pair cable that meets local standards. 	<ul style="list-style-type: none"> • Cable outer diameter: 5.5 mm • Conductor cross-sectional area: 0.2 mm²- 0.3 mm²

No.	Cable	Cable Requirements	Cable Specifications
10	DRED/RCR communication cable	Outdoor copper core cable	<ul style="list-style-type: none"> Cable outer diameter: 5.5 mm Conductor cross-sectional area: 0.75 mm²- 1.5 mm²
11	(Reserved) DO signal cable		
12	RSD		
13	Remote Shutdown		
14	Load Control		
15	Generator Control		

6.3 Wiring Diagram

NOTICE

- The BACK-UP function can only be used when the inverter is paired with STS. The ON-GRID and BACK-UP ports are located on the STS device.
- N and PE wiring ON-GRID and BACK-UP of the inverter are different based on the regulation requirements of different regions. Refer to the specific requirements of local regulations.

The N and PE cables of the BACK-UP load end are connected together for wiring in the distribution box.

This wiring method is suitable for countries such as Australia and New Zealand.

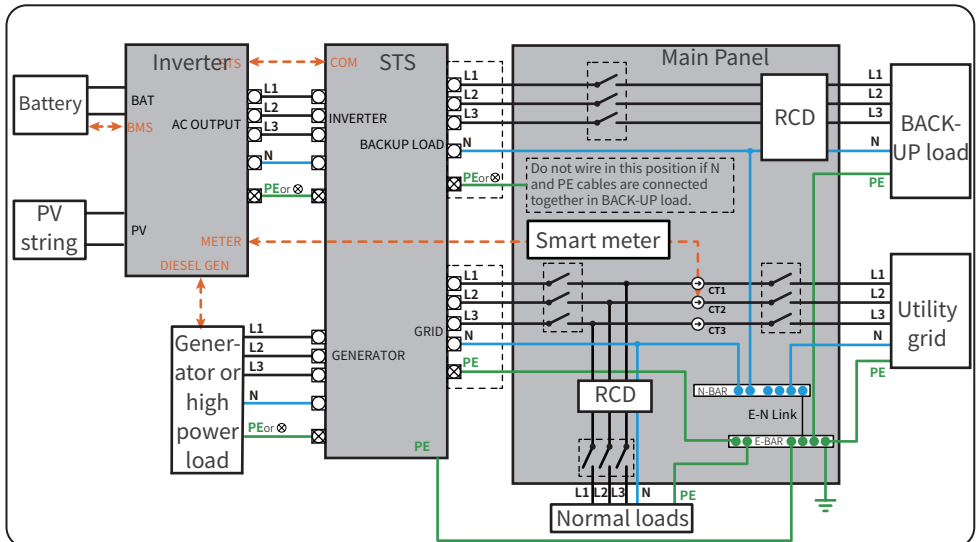

The N and PE cables of the BACK-UP load end shall be wired separately in the distribution box. This wiring method is applicable in many countries except Australia and New Zealand.

NOTICE

If the inverter switches to off grid mode and no need to connect N and PE cables, the "Backup N and PE relay switch" function can be turned off through the "Advanced Settings" interface of the SolarGo App.

- When the inverter switches to off grid mode, the STS internal relay automatically connects, connecting the PE and N cables.
- When the inverter switches to grid connection mode, the STS internal relay automatically disconnects, disconnecting the PE and N cables.

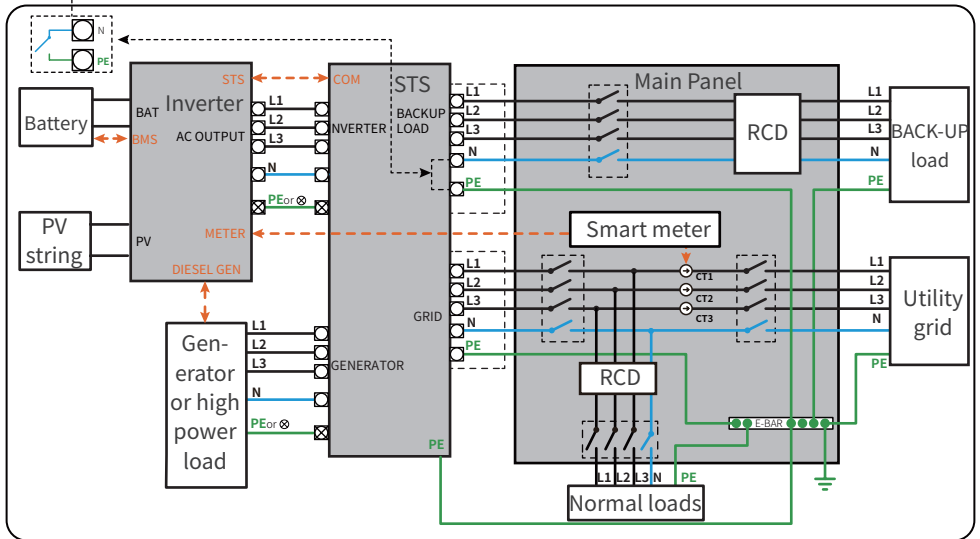

6.4 Connecting the PE cable

WARNING

- The PE cable connected to the enclosure of the inverter cannot replace the PE cable connected to the AC output port. Make sure that both of the two PE cables are securely connected.
- To improve the corrosion resistance of the terminal, you are recommended to apply silica gel or paint on the ground terminal after installing the PE cable.
- The grounding cable should be prepared by customers.

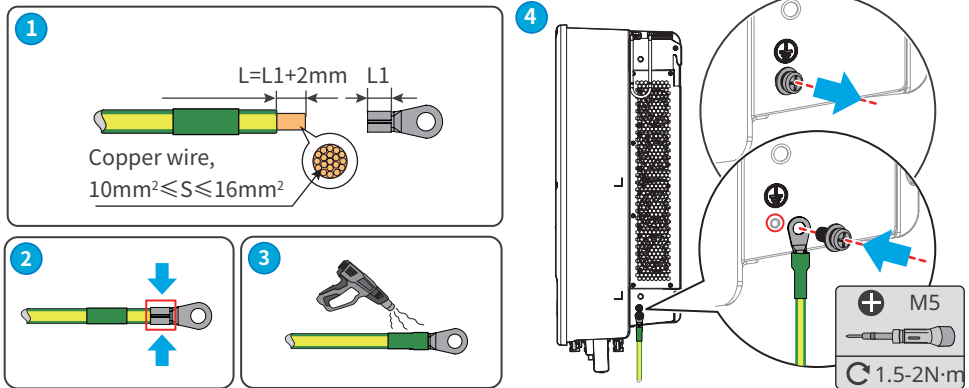

6.5 Connecting the DC Input Cable(PV)

DANGER

- Do not connect one PV string to more than one inverter at the same time. Otherwise, it may cause damage to the inverter.
- The PV strings cannot be grounded. Ensure the minimum insulation resistance of the PV string to the ground meets the minimum insulation resistance requirements before connecting the PV string to the inverter ($R=\text{maximum input voltage}/30\text{mA}$).
- Confirm the following information before connecting the PV string to the inverter. Otherwise, the inverter may be damaged permanently or even cause fire and cause personal and property losses.
 1. Make sure that the max short circuit current and the max input voltage per MPPT are within the permissible range.
 2. Please ensure that the positive and negative poles of the PV string are connected correctly.

WARNING

- Ensure the DC cables are connected tightly, securely and correctly.
- Measure the DC cables using a multimeter to avoid reverse polarity connection. Also, the voltage should be under the permissible range.
- The inverter supports independent MPPT string connection, and it is not recommended to use MPPT string parallel connection, otherwise it will affect the MPPT tracking efficiency.
- The MPPT string parallel connection must meet the requirements of local laws and regulations.

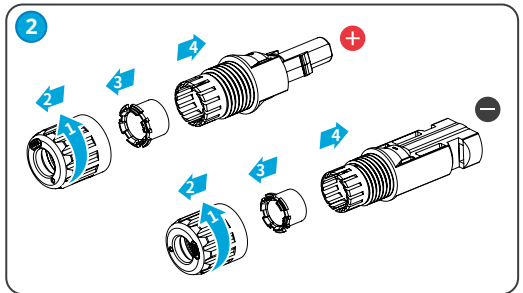
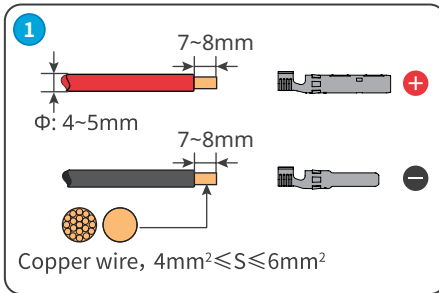
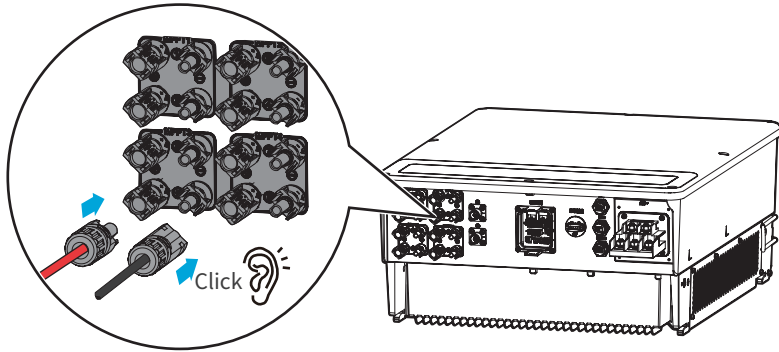

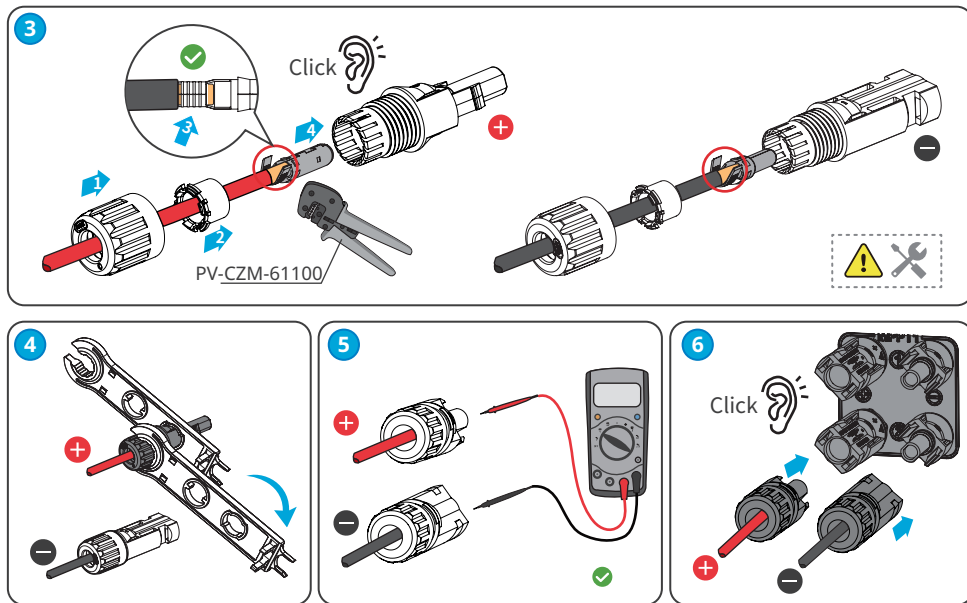

6.6 Connecting the battery cable



- The battery used with the inverter shall be approved by the inverter manufacturer. The approved battery list can be obtained through the official website.
- The positive and negative poles of the battery cannot be grounded. Before connecting the battery to the inverter, please ensure that the minimum insulation resistance to ground of the battery meets the minimum insulation impedance requirement ($R = \text{maximum input voltage} / 30\text{mA}$).
- A short circuit in the battery may cause personal injury. The instantaneous high current caused by a short circuit can release a large amount of energy and may cause a fire.
- Before connecting the battery cable, ensure the inverter and the battery, and downstream&upstream switches, are all disconnected.
- It is forbidden to connect and disconnect the battery cables when the inverter is running. Otherwise it may cause electric shock.
- Do not connect one battery pack to more than one inverter at the same time. Otherwise, it may cause damage to the inverter.
- It is forbidden to connect loads between the inverter and batteries.
- When connecting battery cables, use insulated tools to prevent accidental electric shock or short circuit to the batteries.
- Ensure that the open circuit voltage of the battery is within the permissible range of the inverter.
- Install a DC breaker between the inverter and the battery. If there is a switch on the battery, you can choose whether to equip an extra switch according to local laws and regulations.

WARNING

- Connect the battery cables to the corresponding terminals such BAT+, BAT- and grounding ports correctly. Otherwise it will cause damage to the inverter.
- Ensure the DC cables are connected tightly, securely and correctly.
- Measure the DC cables using a multimeter to avoid reverse polarity connection. Also, the voltage should be under the permissible range.
- The inverter supports the connection of multiple types of batteries. When selecting the battery connection cable, it must be compatible with the battery cable requirements.
- When there is no battery connected, a male terminal of the battery need to be plugged to the inverter.

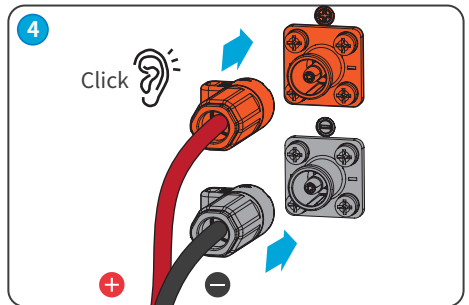
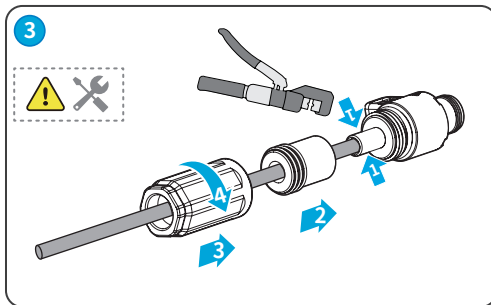
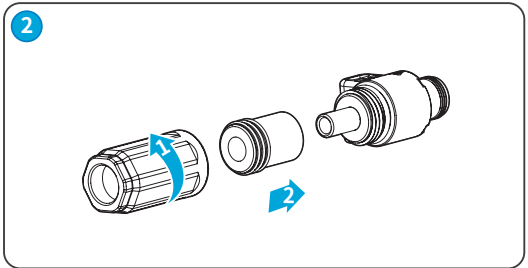
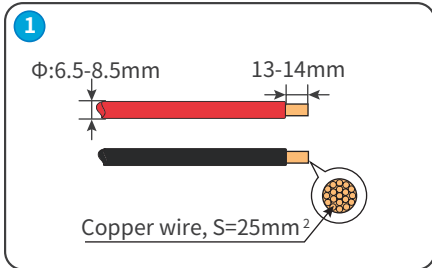
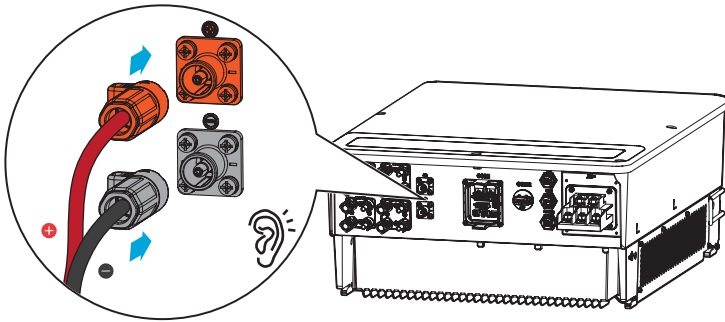

Please refer to the following steps to remove the battery connection terminals.

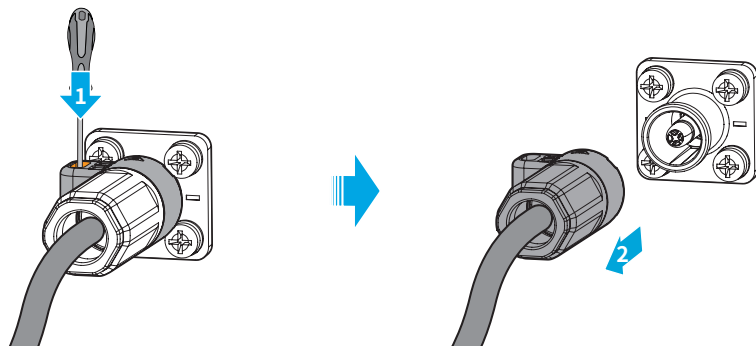

6.7 Connecting the AC Cable

WARNING

- Do not connect loads between the inverter and the AC switch directly connected to the inverter.
- An AC circuit breaker should be installed on the AC side to make sure that the inverter can safely disconnect the grid when an exception happens. Install one AC circuit breaker for each inverter. Multiple inverters cannot share one AC circuit breaker. Select an appropriate AC circuit breaker in compliance with local laws and regulations.
- The residual current monitoring unit (RCMU) is integrated into the inverter. When the leakage current exceeds the allowable limit, the inverter will disconnect from the grid quickly.

Connect a Residual Current Device (RCD for short) based on local laws and regulations. Type A RCDs can be connected to the outside of the inverter for protection when the DC component of the leakage current exceeds the limit value. The following RCDs are for reference:

No.	Inverter Model	RCD Specification
1	GW40K-ET-10	400mA
2	GW50K-ET-10	500mA

WARNING

- When wiring, the AC cable matches the "L1", "L2", "L3", "N" and "PE" ports of the AC terminals perfectly. If the cable connection is incorrect, it may cause power outage.
- Ensure that the whole cable cores are inserted into the terminal holes. No part of the cable core can be exposed.
- Ensure that the cables are connected securely. Otherwise it will cause damage to the inverter due to overheat during its operation.

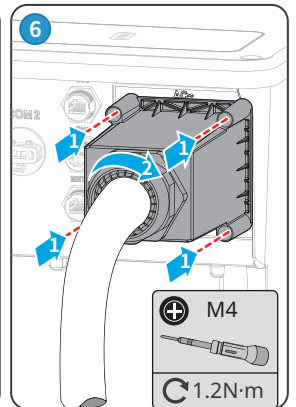
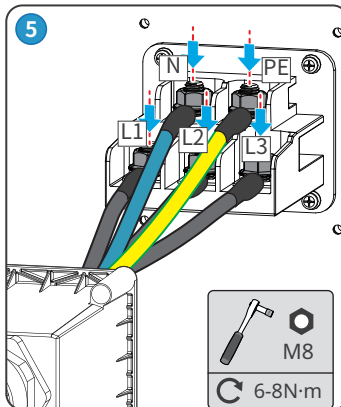
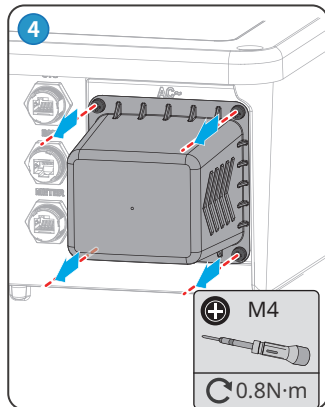
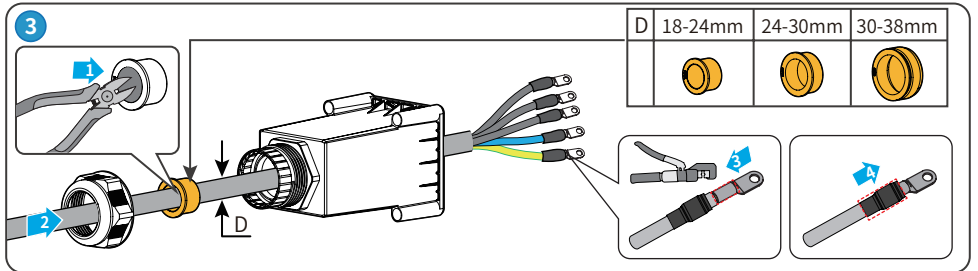
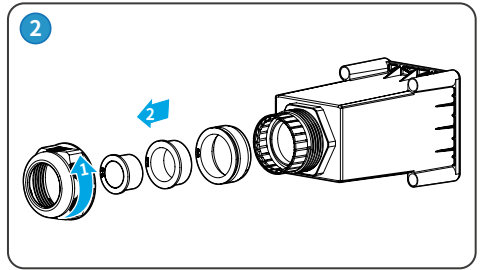
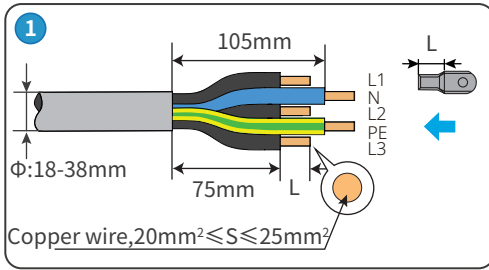
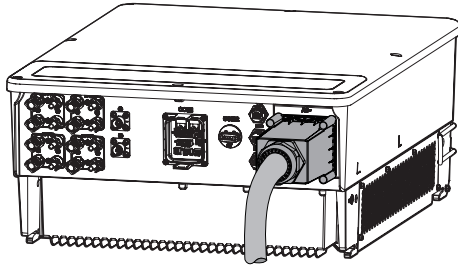

6.8 Communication

NOTICE

Make sure that the communication device is connected to the right COM port. Route the communication cable far away from any interference source or power cable to prevent the signal from being influenced.

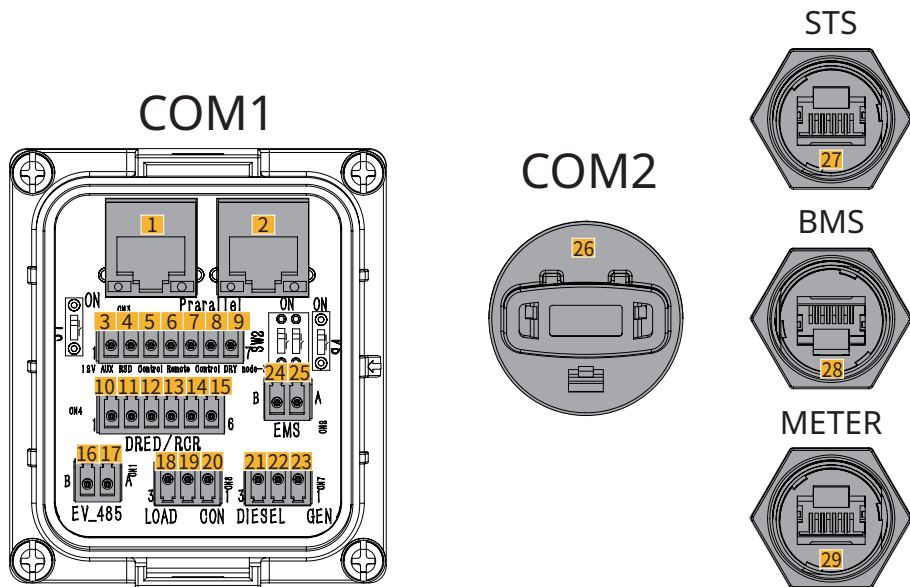

No.	Function		Intended usage
1	(Reserved) Parallel communication port, RS485 communication port (Parallel/RS485)	1. Orange and White:-	<ul style="list-style-type: none"> CAN and BUS ports: parallel communication ports, use CAN communication to connect other inverters in the unit; use BUS bus to control the on grid and off grid status of each inverter in parallel system. RS485 port: Use RS485 communication to connect EMS devices.
2		2. Orange:-	
	3. Green and White: HIGH_SYN_BUS		
	4. Blue: DGND_S		
	5. Blue and White: CANL_M		
	6. Green: CANH_M		
	7. Brown and White: PARA_CANH		
	8. Brown: PARA_CANL		
3	(Optional) RSD Control	GND_S1	<ul style="list-style-type: none"> Optional Connect the RSD and control it to stop working in case of accidents.
4		+12V_S	
5		RSD_12V	

No.	Function		Intended usage
6	(Optional) Remote Control port	DGND_S	<ul style="list-style-type: none"> When an accident occurs, the equipment can be controlled to shut down.
7		IO1	
8	(Reserved) Dry contact (DRY node-3)	DO-	Reserved
9		DO+	
10	(Optional) DRED or RCR function connection port (DRED/RCR)	DRM0 or REF_1	<ul style="list-style-type: none"> DRED (Demand Response Enabling Device): The inverter meets the Australian DERD certification requirements and provides a DRED signal control port. RCR Ripple Control Receiver: In Germany and some European regions, power grid companies use Ripple Control <p>Receiver to convert power grid dispatch signals into dry contact mode for transmission, and power stations receive power grid dispatch signals through dry contact communication.</p>
11		REFGEN or REF_2	
12		DRM4/8 or DI_4	
13		DRM3/7 or DI_3	
14		DRM2/6 or DI_2	
15		DRM1/5 or DI_1	
16	(Reserved) Charging station communication connection port (EV_485)	RS485_A4	(Reserved) For RS485 communication of electric vehicle charging piles.
17		RS485_B4	
18	(Optional) Load control port (LOAD CON)	DO+	<p>The inverter has a dry contact controlling port, which supports connecting additional contactors to enable/disable the load.</p> <p>The load control mode is turned off by default, and the dry contact signal is open circuit; after the load control mode is turned on, the dry contact signal becomes short circuit.</p>
19		NC	
20		DO-	
21	(Optional) Generator start/stop control port (DIESEL GEN)	DO+	<p>It supports the access of generator signal.</p> <p>The generator control mode is turned off by default, and the dry contact signal is open circuit; after the control mode is turned on, the dry contact signal becomes short circuit.</p>
22		NC	
23		DO-	
24	Energy management system connection port (EMS)	RS485_B3	RS485 communication port used to connect third-party EMS devices.
25		RS485_A3	

No.	Function		Intended usage
26	Communication module port (COM2)	-	Connect WiFi/LAN Kit-20 or 4G module for remote monitoring of equipment.
27	STS communication port (STS)	1. Orange and White: +12V_S 2. Orange: GND_S 3. Green and white: GND_S 4. Blue: STS_TX 5. Blue and white: 485_A1 6. Green: 485_A1 7. Brown and white: 485_B1 8. Brown: 485_B1	Used to connect the STS communication cable.
28	Battery system communication port (BMS)	3. Green and White: NC 4. Blue: CANH1 5. Blue and white: CANL1 Others: -	Connect the battery system CAN signal communication port.
29	Meter communication port (METER)	7. Brown and white: RS485_B1 8. Brown: RS485_A1 Others: -	Using RS485 communication to connect smart meters

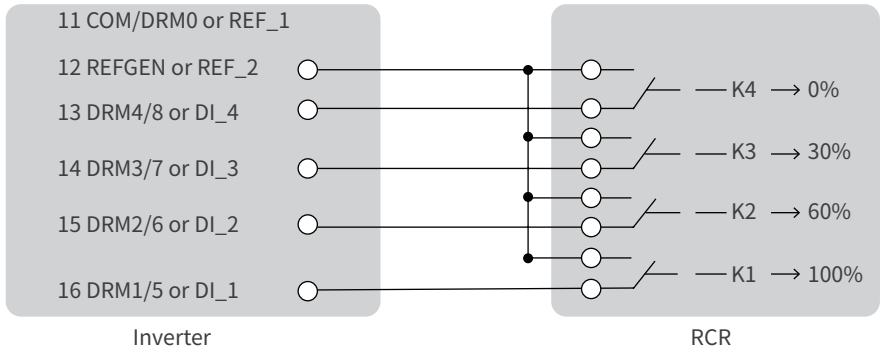

Load monitoring and output power limitation networking

The inverter can monitor the load electricity consumption and control the inverter's real-time output power through the connection of GM3000 or GM330 smart meter.

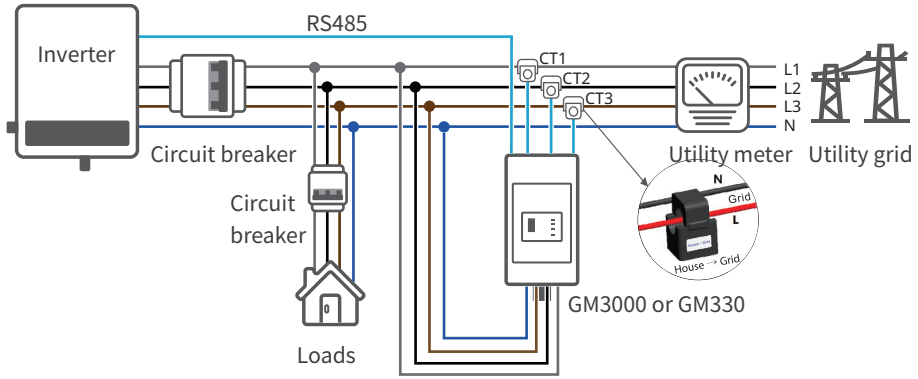

Scenarios with STS:

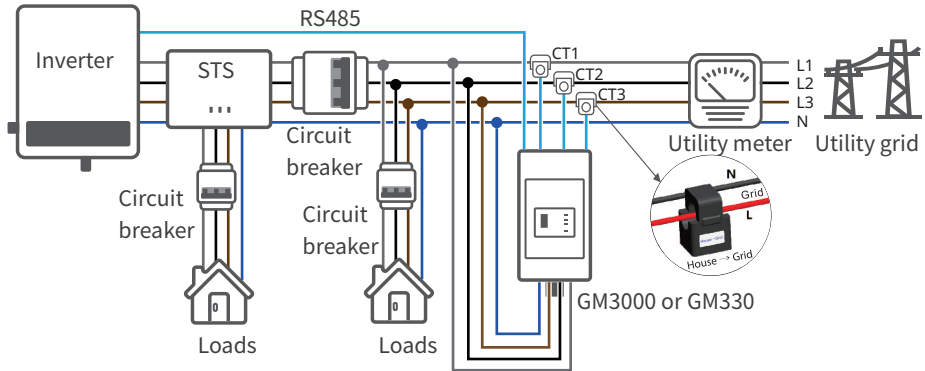

After the wiring is completed, the "Advanced Settings" interface on the SolarGo App can be used to set the relevant parameters of "Power Limit" to complete the power limit functions.

6.8.1 Connecting the Communication Cable

NOTICE

- Enable the DRED, RCR function or remote shutdown function via SolarGo App after cable connections.
- The Inverter paralleling function is reserved.
- Only in inverter paralleling scenarios, you need to connect the parallel communication cables between inverters.
- Parallel communication cable should be prepared by the customers.
- Communication cables for DRED, RCR, or remote shutdown functions should be prepared by the customers.

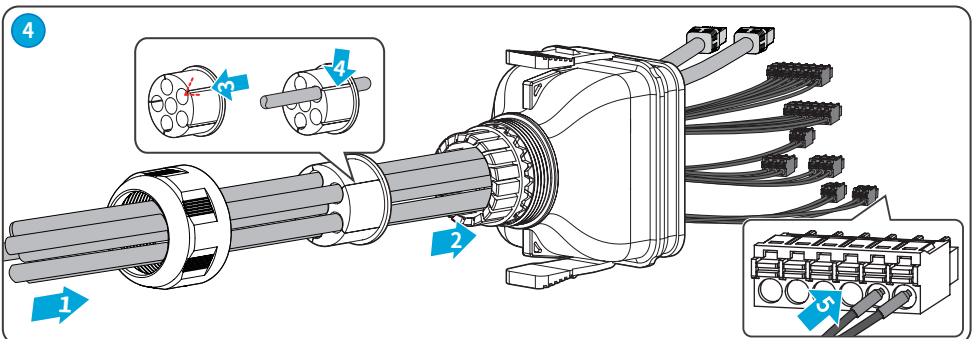
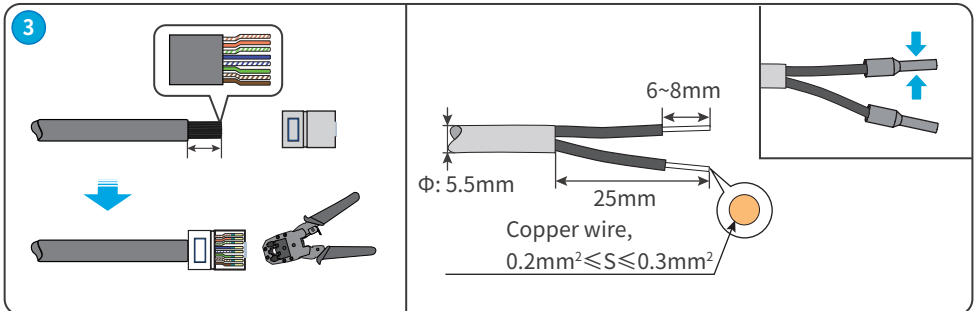
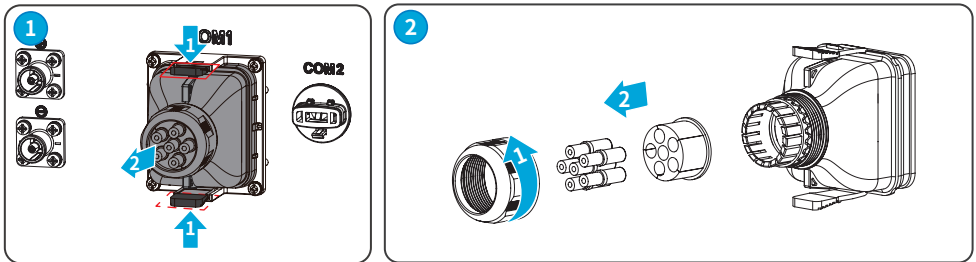

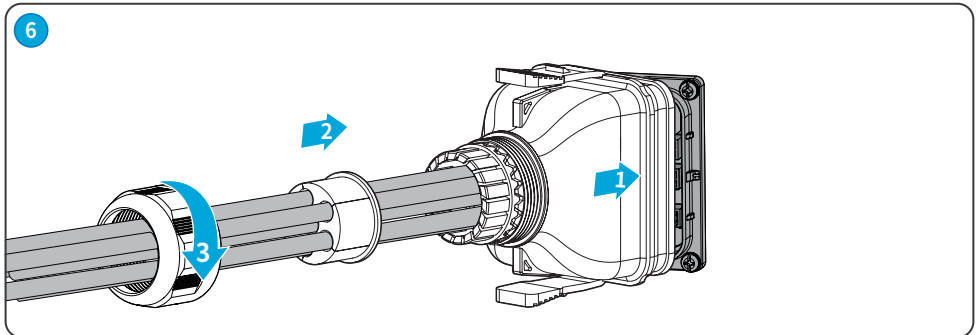
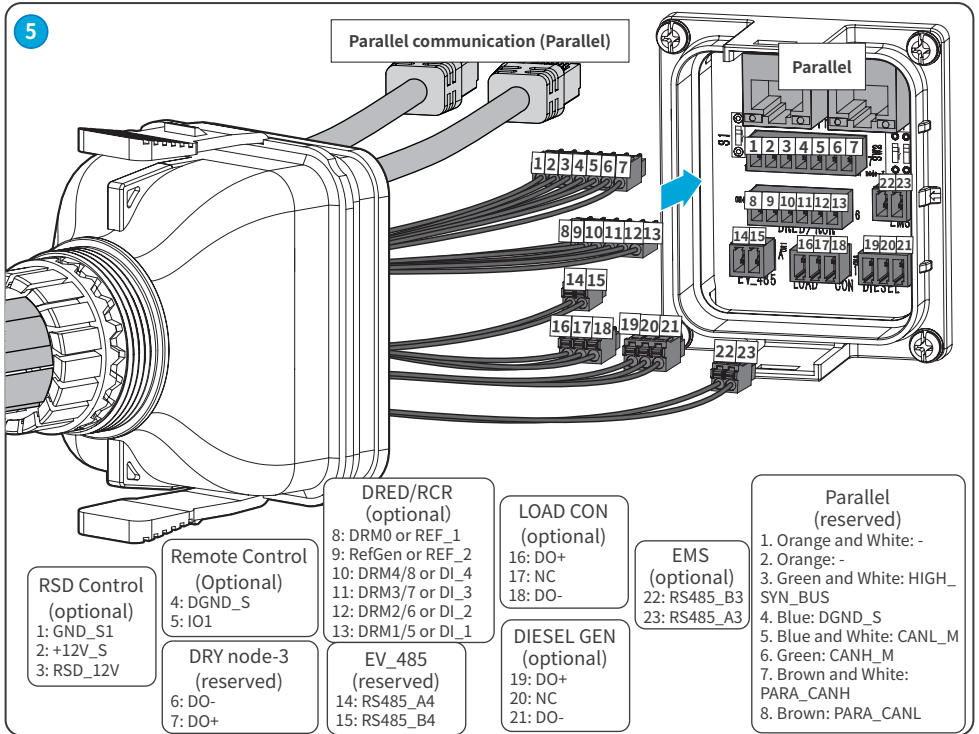

6.8.2 (Optional) Connecting the STS/ BMS/ METER communication cable

NOTICE

- Please use the communication cable shipped with the box.
- The STS communication cable is shipped with STS accessories.
- If the length of the communication cable shipped with the box cannot meet the actual needs, please prepare standard network cable and RJ45 connector.
- After the communication cable is connected, please take waterproof protection measures.

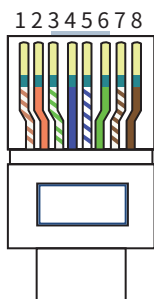

No.	Color	STS	BMS	METER
1	Orange and White	+12V_S	-	-
2	Orange	GND_S	-	-
3	Green and White	GND_S	-	-
4	Blue	STS_TX	CANH1	-
5	Blue and White	485_A1	CANL1	-
6	Green	485_A1	-	-
7	Brown and White	485_B1	-	RS485_B1
8	Brown	485_B1	-	RS485_A1

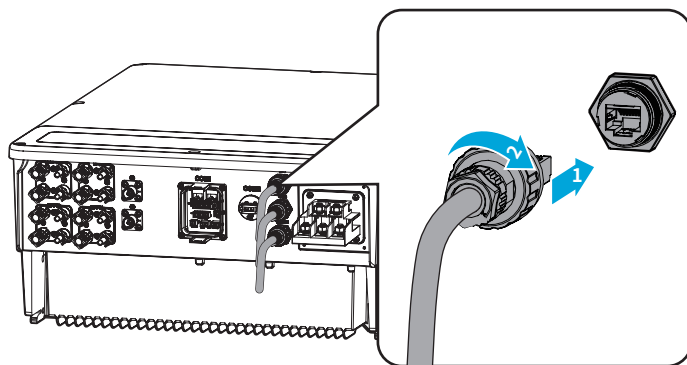

6.9 Installing the Communication Module

The inverter supports connecting to mobile phones or web interfaces through communication modules such as WiFi/LAN Kit-20 and 4G to set device related parameters, view device operation information and error messages, and timely understand system status.

NOTICE

- Refer to the delivered communication module user manual to get more introduction to the module. For more detailed information, visit www.goodwe.com.
- When replacing the communication module, the interval between reinstalling the module should be at least 5 seconds if the inverter is in operation.

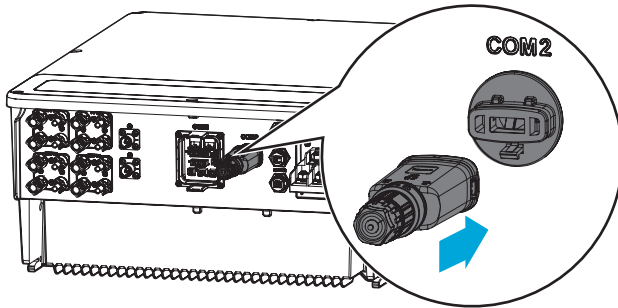

7 Equipment Commissioning

7.1 Check Before Power ON

No.	Check Item
1	The product is firmly installed at a clean place that is well-ventilated and easy-to operate.
2	The PE, DC input, AC output, and communication cables are connected correctly and securely.
3	Cable ties are intact, routed properly and evenly.
4	Unused cable holes are fitted using the waterproof nuts.
5	The electrical conduit holes are sealed.
6	The voltage and frequency at the connection point meet the inverter grid connection requirements.

7.2 Power On/Off

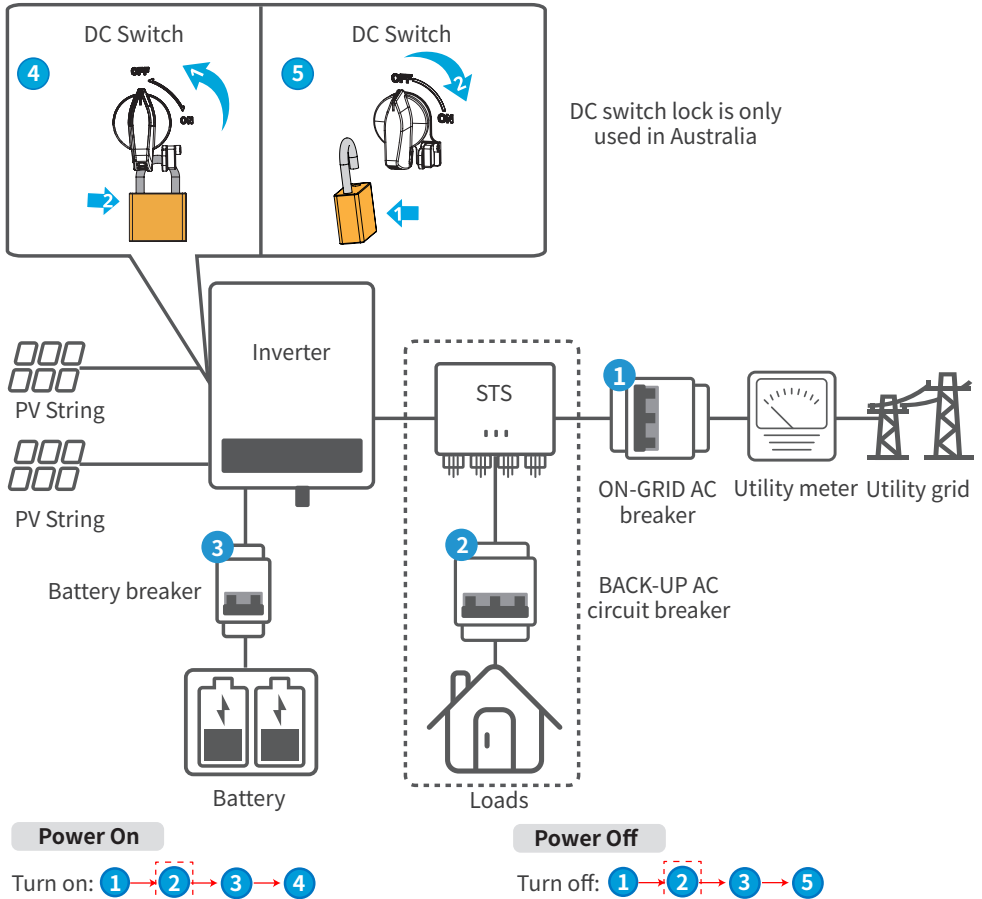

Steps for starting the battery for the first time after it disconnected from grid.

NOTICE

















- Off-grid mode can be used with STS.
- Steps for starting the battery for the first time after it disconnected from grid are only applicable when there is no power on the grid side and PV side, and it is necessary to enable the off grid function.
- The correctness of cable connection can not be confirmed if there is no power on the grid and PV sides. If the cable connection is abnormal, it may cause abnormal operation of the energy storage system when the grid and PV power supply are restored. Please try to avoid using this mode to start the equipment.
- After the switch is connected, please turn on the "Self-starting (Off-grid)" through the "Back-up" interface of the SolarGo App to start the energy storage system.

Turn on: 





8 System Commissioning

8.1 Inverter Indicators

Indicator Description

Indicator	Status	Description
 SYSTEM		The inverter is power on and in the standby mode.
		The inverter is starting up and in the self-check mode.
		The inverter is in normal operation under grid-tied or off-grid mode.
		BACK-UP output overload.
		A fault has occurred.
		The inverter is powered off.
 BACK-UP		The grid is abnormal, and the power supply to the BACK-UP port of the inverter is normal.
		The grid is normal, and the power supply to the BACK-UP port of the inverter is normal.
		The BACK-UP port has no power supply
 COM		The monitoring module of the inverter is resetting.
		The inverter fails to connect with the communication Termination.
		Communication fault between the communication Termination and Server.
		The monitoring of the inverter operates well.
		The monitoring module of the inverter has not been started yet.

Battery SOC indicator

Indicator	Description
	SOC=100%
	SOC=75%
	SOC=50%
	SOC=25%
	No battery connected

Indicator light blinking: for example, when the battery SOC is between 25% and 50%, the light at the 50% position blinks.

8.2 Setting Inverter Parameters via SolarGo App

NOTICE

Please set the inverter parameters first via SolarGo app to ensure its operation.

SolarGo app is a smart phone application used to communicate with the inverter via Bluetooth, WiFi, or 4G modules. Commonly used functions are as follows:

1. Check the operating data, software version, alarms, etc.
2. Set grid parameters, communication parameters, etc.
3. Equipment maintenance.
4. Upgrade software version.

For more details, refer to SolarGo User Manual. Scan the QR code or visit https://en.goodwe.com/Ftp/EN/Downloads/User%20Manual/GW_SolarGo_User%20Manual-EN.pdf to get the user manual.



SolarGo App



SolarGo App User Manual

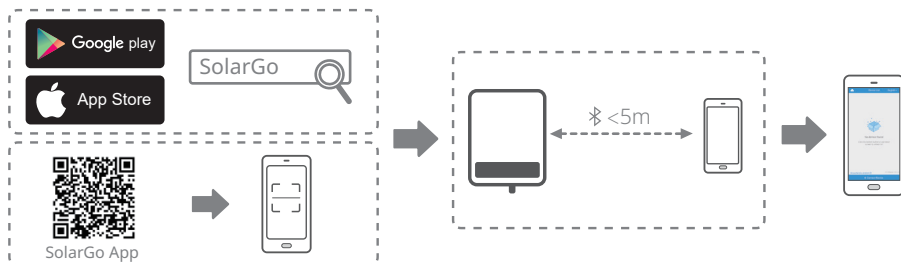

8.3 Monitoring via SEMS Portal

NOTICE

In parallel system, only the master inverter needs to be added to the SEMS Portal monitoring platform, which can obtain all inverter information from the parallel system. If the slave inverter is added to the SEMS Portal monitoring platform, it will result in duplicate or distorted data in the parallel system.

SEMS Portal is an monitoring platform used to communicate with the equipment via WiFi, LAN or 4G. Commonly used functions:

1. Manage the organization or User information;
2. Add and monitor the power plant information;
3. Equipment maintenance.



SEMS Portal

9 Maintenance

9.1 Power OFF the Inverter



- Power off the inverter before operations and maintenance. Otherwise, the inverter may be damaged or electric shocks may occur.
- Delayed discharge. Wait until the components are discharged after power off.

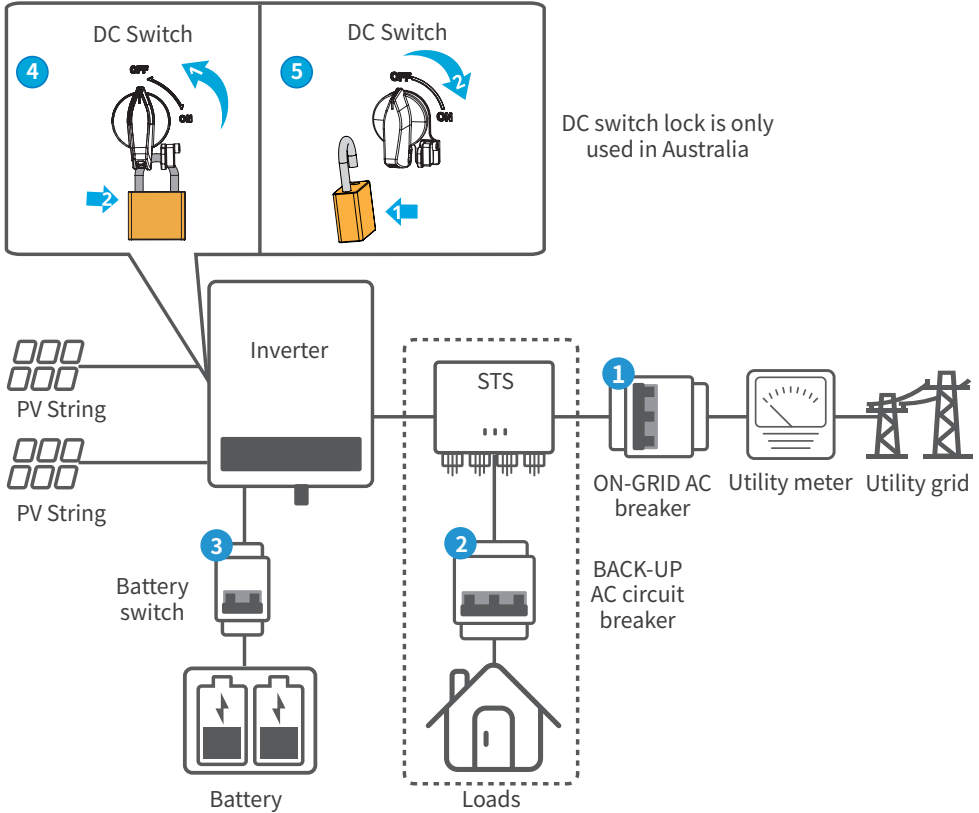

Step 1: Turn off the AC switch between the inverter and the utility grid; when in the STS scenarios, turn off the AC switch between the STS and the power grid.

Step 2: In the STS scenarios, turn off the AC switch between the STS and the loads.

Step 3: Turn off the DC switch between the inverter and the battery.

Step 4: (Optional) Turn off the DC switch between the inverter and the PV string.

9.2 Removing the Inverter

WARNING

- Make sure that the inverter is powered off.
- Wear proper PPE before any operations.

Step 1 Disconnect all the cables, including DC cables, AC cables, communication cables, the communication module, and PE cables.

Step 2 Remove the inverter from the mounting plate.

Step 3 Remove the mounting plate.

Step 4 Store the inverter properly. Ensure that the storage conditions meet the requirements for future use.

9.3 Disposing of the Inverter

If the inverter cannot work anymore, dispose of it according to the local disposal requirements for electrical equipment waste. The inverter cannot be disposed of together with household waste.

9.4 Troubleshooting

Perform troubleshooting according to the following methods. Contact the after-sales service if these methods do not work.

Collect the information below before contacting the after-sales service, so that the problems can be solved quickly.

1. Inverter information like serial number, software version, installation date, fault time, fault frequency, etc.
2. Installation environment, including weather conditions, whether the PV modules are sheltered or shadowed, etc. It is recommended to provide some photos and videos to assist in analyzing the problem.
3. Utility grid situation.

No.	Fault	Cause	Solutions
1	Utility Loss	1. Utility grid power fails. 2. The AC cable is disconnected, or the AC breaker is off.	1. The alarm is automatically cleared after the grid power supply is restored. 2. Check whether the AC cable is connected and the AC breaker is on.
2	Grid Overvoltage	The grid voltage exceeds the permissible range, or the duration of high voltage exceeds the requirement of HVRT.	1. If the problem occurs occasionally, the utility grid may be abnormal temporarily. The inverter will recover automatically after detecting that the utility grid is normal. 2. If the problem occurs frequently, check whether the grid voltage is within the permissible range. <ul style="list-style-type: none"> • Contact the local power company if the grid voltage exceeds the permissible range. • Modify the overvoltage protection threshold, HVRT or disable the overvoltage protection function after obtaining the consent of the local power company if the grid frequency is within the permissible range. 3. Check whether the AC breaker and the output cables are connected securely and correctly if the problem persists.
3	Grid Rapid Overvoltage	The grid voltage is abnormal or ultra-high.	1. If the problem occurs occasionally, the utility grid may be abnormal temporarily. The inverter will recover automatically after detecting that the utility grid is normal. 2. If the problem occurs frequently, check whether the grid voltage is within the allowed range. <ul style="list-style-type: none"> • Contact the local power company if the grid voltage exceeds the permissible range. • Modify the grid overvoltage rapid protection threshold after obtaining the consent of the local power company if the grid voltage is within the permissible range.

No.	Fault	Cause	Solutions
4	Grid Undervoltage	The grid voltage is lower than the permissible range, or the duration of low voltage exceeds the requirement of LVRT.	<ol style="list-style-type: none"> 1. If the problem occurs occasionally, the utility grid may be abnormal temporarily. The inverter will recover automatically after detecting that the utility grid is normal. 2. If the problem occurs frequently, check whether the grid voltage is within the permissible range. <ul style="list-style-type: none"> • Contact the local power company if the grid voltage exceeds the permissible range. • Modify the undervoltage protection threshold, LVRT or disable the undervoltage protection function after obtaining the consent of the local power company if the grid frequency is within the permissible range. 3. Check whether the AC breaker and the output cables are connected securely and correctly if the problem persists.
5	Grid 10min Overvoltage	The moving average of grid voltage in 10min exceeds the range of safety requirements.	<ol style="list-style-type: none"> 1. If the problem occurs occasionally, the utility grid may be abnormal temporarily. The inverter will recover automatically after detecting that the utility grid is normal. 2. If the problem occurs frequently, check whether the grid voltage is within the allowed range. <ul style="list-style-type: none"> • Contact the local power company if the grid voltage exceeds the permissible range. • Modify the grid overvoltage rapid protection threshold after obtaining the consent of the local power company if the grid voltage is within the permissible range.

No.	Fault	Cause	Solutions
6	Grid Overfrequency	Utility grid exception. The actual grid frequency exceeds the requirement of the local grid standard.	<ol style="list-style-type: none"> 1. If the problem occurs occasionally, the utility grid may be abnormal temporarily. The inverter will recover automatically after detecting that the utility grid is normal. 2. If the problem occurs frequently, check whether the grid frequency is within the permissible range. <ul style="list-style-type: none"> • Contact the local power company if the grid frequency exceeds the permissible range. • Modify the overfrequency protection threshold or disable the overfrequency protection function after obtaining the consent of the local power company if the grid frequency is within the permissible range.
7	Grid Underfrequency	Utility grid exception. The actual grid frequency is lower than the requirement of the local grid standard.	<ol style="list-style-type: none"> 1. If the problem occurs occasionally, the utility grid may be abnormal temporarily. The inverter will recover automatically after detecting that the utility grid is normal. 2. If the problem occurs frequently, check whether the grid frequency is within the permissible range. <ul style="list-style-type: none"> • Contact the local power company if the grid frequency exceeds the permissible range. • Modify the underfrequency protection threshold or disable the underfrequency protection function after obtaining the consent of the local power company if the grid frequency is within the permissible range. Or close “Grid Underfrequency” function.

No.	Fault	Cause	Solutions
8	Grid Frequency Instability	Utility grid exception. The actual grid frequency change rate does not meet the requirement of the local grid standard.	<ol style="list-style-type: none"> If the problem occurs occasionally, the utility grid may be abnormal temporarily. The inverter will recover automatically after detecting that the utility grid is normal. If the problem occurs frequently, check whether the grid frequency is within the permissible range. <ul style="list-style-type: none"> Contact the local power company if the grid frequency exceeds the permissible range. Contact the dealer or the after-sales service if the grid frequency is within the permissible range.
9	Anti-islanding	The utility grid is disconnected. The utility grid is disconnected according to the safety regulations, but the grid voltage is maintained due to the loads.	<ol style="list-style-type: none"> Check whether the utility grid is disconnected. Contact the dealer or the after-sales service.
10	LVRT Undervoltage	Utility grid exception. The duration of the utility grid exception exceeds the set time of LVRT.	<ol style="list-style-type: none"> If the problem occurs occasionally, the utility grid may be abnormal temporarily. The inverter will recover automatically after detecting that the utility grid is normal. If the problem occurs frequently, check whether the grid frequency is within the permissible range.
11	HVRT Overvoltage	Utility grid exception. The duration of utility grid exception exceeds the set time of HVRT.	<ol style="list-style-type: none"> If the problem occurs frequently, check whether the grid frequency is within the permissible range. If not, contact the local power company. If yes, contact the dealer or the after-sales service.

No.	Fault	Cause	Solutions
12	Abnormal GFCI 30mA	The input insulation impedance becomes low when the inverter is working.	<ol style="list-style-type: none"> If the problem occurs occasionally, it may be caused by a cable exception. The inverter will recover automatically after the problem is solved. Check whether the impedance between the PV string and PE is too low if the problem occurs frequently or persists.
13	Abnormal GFCI 60mA		
14	Abnormal GFCI 150mA		
15	Abnormal GFCI		
16	Large DC of AC current L1	The DC component of the output current exceeds the safety range or default range.	<ol style="list-style-type: none"> If the problem is caused by an external fault like a utility grid exception or frequency exception, the inverter will recover automatically after solving the problem. If the problem occurs frequently and the PV station cannot work properly, contact the dealer or the after-sales service.
17	Large DC of AC current L2		
18	Low Insulation Res.	<ol style="list-style-type: none"> The PV string is short-circuited to PE. The PV system is in a moist environment and the cable is not well insulated to the ground. 	<ol style="list-style-type: none"> Check whether the resistance of the PV string to PE exceeds 100kΩ. If no, check the short circuit point. Check whether the PE cable is connected correctly. If the resistance is lower than default on rainy days, please reset the ISO.
19	Abnormal Ground	<ol style="list-style-type: none"> The PE cable of the inverter is not connected well. The L cable and N cable are connected reversely when output of the PV string is grounded. 	<ol style="list-style-type: none"> Check whether the PE cable of the inverter is connected properly. Check whether the L cable and N cable are connected reversely if output of the PV string is grounded.

No.	Fault	Cause	Solutions
20	Anti Reverse power Failure	Abnormal fluctuation of load	<ol style="list-style-type: none"> 1. If the exception is caused by an external fault, the inverter will recover automatically after solving the problem. 2. If the problem occurs frequently and the PV station cannot work properly, contact the dealer or the after-sales service.
21	Internal Comm Loss	<ol style="list-style-type: none"> 1. Frame format error 2. Parity checking error 3. Can bus offline 4. Hardware CRC error 5. Send (receive) control bit is receive (send). 6. Transmit to the unit that is not allowed. 	<p>Disconnect the AC output switch and DC input switch, then connect them 5 minutes later. Contact the dealer or the after-sales service if the problem persists.</p>
22	AC HCT Check abnormal	The sampling of the AC HCT is abnormal.	<p>Disconnect the AC output switch and DC input switch, then connect them 5 minutes later. Contact the dealer or the after-sales service if the problem persists.</p>
23	GFCI HCT Check abnormal	The sampling of the GFCI HCT is abnormal.	<p>Disconnect the AC output switch and DC input switch, then connect them 5 minutes later. Contact the dealer or the after-sales service if the problem persists.</p>
24	Relay Check abnormal	<ol style="list-style-type: none"> 1. The relay is abnormal or short-circuited. 2. The control circuit is abnormal. 3. The AC cable connection is abnormal, like a virtual connection or short circuit. 	<p>Disconnect the AC output switch and DC input switch, then connect them 5 minutes later. Contact the dealer or the after-sales service if the problem persists.</p>

No.	Fault	Cause	Solutions
26	Flash Fault	The internal Flash storage is abnormal.	Disconnect the AC output switch and DC input switch, then connect them 5 minutes later. Contact the dealer or the after-sales service if the problem persists.
27	DC Arc Fault	<ol style="list-style-type: none"> The DC terminal is not firmly connected. The DC cable is broken. 	Read the Quick Installation Guide and check whether the cables are connected properly.
28	AFCI Self-test Fault	AFCI detection is abnormal.	Disconnect the AC output switch and DC input switch, then connect them 5 minutes later. Contact the dealer or the after-sales service if the problem persists.
29	Cavity Overtemperature	<ol style="list-style-type: none"> The inverter is installed in a place with poor ventilation. The ambient temperature exceeds 60°C. A fault occurs in the internal fan of the inverter. 	<ol style="list-style-type: none"> Check the ventilation and the ambient temperature at the installation point. If the ventilation is poor or the ambient temperature is too high, improve the ventilation and heat dissipation. Contact the dealer or after-sales service if both the ventilation and the ambient temperature are normal.
30	BUS Overvoltage	<ol style="list-style-type: none"> The PV voltage is too high. The sampling of the inverter BUS voltage is abnormal. 	Disconnect the AC output switch and DC input switch, then connect them 5 minutes later. Contact the dealer or the after-sales service if the problem persists.
31	PV Input Overvoltage	The PV array configuration is not correct. Too many PV panels are connected in series in the PV string.	Check the serial connection of the PV array. Make sure that the open circuit voltage of the PV string is not higher than the maximum operating voltage of the inverter.
32	PV Continuous Hardware Overcurrent	<ol style="list-style-type: none"> The PV configuration is not proper. The hardware is damaged. 	Disconnect the AC output switch and DC input switch, then connect them 5 minutes later. Contact the dealer or the after-sales service if the problem persists.

No.	Fault	Cause	Solutions
33	PV Continuous Software Overcurrent	<ol style="list-style-type: none"> The PV configuration is not proper. The hardware is damaged. 	Disconnect the AC output switch and DC input switch, then connect them 5 minutes later. Contact the dealer or the after-sales service if the problem persists.
34	String1 PV String Reversed	The PV string is connected reversely.	Check whether the PV1 and PV2 strings are connected reversely.
35	String2 PV String Reversed		
36	String3 PV String Reversed		
37	String4 PV String Reversed		
38	Extern Comm Loss	<p>Communication between the inverter and external STS device fails:</p> <p>STS power supply abnormality</p> <p>The communication protocols of STS and inverter do not match.</p>	Check whether the STS is working properly.
39	Connect Box Failure	The on-grid and off-grid switch of STS takes too long.	Check whether the STS relay is faulty.

No.	Fault	Cause	Solutions
40	Internal Fan abnormal	Internal fan abnormal, possible reason: 1. The power supply of the fan is abnormal. 2. Mechanical exception(stuck rotor). 3. The fan is aging and damaged.	Disconnect the AC output switch and DC input switch, then connect them 5 minutes later. Contact the dealer or the after-sales service if the problem persists.
41	External Fan abnormal	External fan abnormal, possible reason: 1. The power supply of the fan is abnormal. 2. Mechanical exception(stuck rotor). 3. The fan is aging and damaged.	

9.5 Routine Maintenance

Maintaining Item	Maintaining Method	Maintaining Period
System Clean	Check the heat sink, air intake, and air outlet for foreign matter or dust.	Once 6-12 months
DC Switch	Turn the DC switch on and off ten consecutive times to make sure that it is working properly.	Once a year
Electrical Connection	Check whether the cables are securely connected. Check whether the cables are broken or whether there is any exposed copper core.	Once 6-12 months
Sealing	Check whether all the terminals and ports are properly sealed. Reseal the cable hole if it is not sealed or too big.	Once a year

10 Technical Parameters

Technical Data	GW40K-ET-10	GW50K-ET-10
Battery Input Data		
Battery Type	Li-Ion	Li-Ion
Nominal Battery Voltage (V)	500	500
Battery Voltage Range (V)	200~800	200~800
Start-up Voltage (V)	200	200
Number of Battery Input	1	1
Max. Continuous Charging Current (A)	100	100
Max. Continuous Discharging Current (A)	100	100
Max. Charge Power (W)	44,000	55,000
Max. Discharge Power (W)	44,000	55,000
PV String Input Data		
Max. Input Power (W) ²	60,000	75,000
Max. Input Voltage (V)	1000	1000
MPPT Operating Voltage Range (V)	165~850	165~850
MPPT Voltage Range at Nominal Power (V)	400~850	400~850
Start-up Voltage (V)	160	160
Nominal Input Voltage (V)	620	620
Max. Input Current per MPPT (A)	42/32/42	42/32/42/32
Max. Short Circuit Current per MPPT (A)	55/42/55	55/42/55/42
Max. Backfeed Current to The Array (A)	0	0
Number of MPP Trackers	3	4
Number of Strings per MPPT	2	2
AC Output Data (On-grid)		
Nominal Output Power (W)	40,000	50,000
Max. Output Power (W)	40,000	50,000
Nominal Apparent Power Output to Utility Grid (VA)	40,000	50,000
Max. Apparent Power Output to Utility Grid (VA)	40,000	50,000
Nominal Apparent Power from Utility Grid (VA)	40,000	50,000
Max. Apparent Power from Utility Grid (VA)	40,000	50,000
Nominal Output Voltage (V)	380/400, 3L/N/PE	380/400, 3L/N/PE
Output Voltage Range (V) ³	176~276	176~276
Nominal AC Grid Frequency (Hz)	50/60	50/60

Technical Data	GW40K-ET-10	GW50K-ET-10
AC Grid Frequency Range (Hz)	45~65	45~65
Max. AC Current Output to Utility Grid (A)	60.6	75.8
Max. AC Current From Utility Grid (A)	60.6	75.8
Max. Output Fault Current (Peak and Duration) (A)	178@2 μ s	178@2 μ s
Inrush Current (Peak and Duration) (A)	178@2 μ s	178@2 μ s
Nominal Output Current (A)	58.0	72.5
Power Factor	~1 (Adjustable from 0.8 leading to 0.8 lagging)	~1 (Adjustable from 0.8 leading to 0.8 lagging)
Max. Total Harmonic Distortion	<3%	<3%
Maximum Output Overcurrent Protection (A)	156	156
AC Output Data (Back-up)* ¹		
Back-up Nominal Apparent Power (VA)	40,000	50,000
Max. Output Apparent Power(VA)	44,000 (48,000 at 60sec, 60,000 at 10sec)	55,000 (60,000 at 60sec, 75,000 at 10sec)
Nominal Output Current (A)	58.0	72.5
Max. Output Current (A)	66.7	83.3
Max. Output Fault Current (Peak and Duration) (A)	178@2 μ s	178@2 μ s
Inrush Current (Peak and Duration) (A)	178@2 μ s	178@2 μ s
Maximum Output Overcurrent Protection (A)	156	156
Nominal Output Voltage (V)	380/400, 3L/N/PE	380/400, 3L/N/PE
Nominal Output Frequency (Hz)	50/60	50/60
Output THDv (@Linear Load)	<3%	<3%
Efficiency		
Max. Efficiency	98.1%	98.1%
European Efficiency	97.50%	97.50%
Max. Battery to AC Efficiency	97.7%	97.7%
MPPT Efficiency	99.00%	99.00%
Protection		
Residual Current Monitoring	Integrated	Integrated
PV Reverse Polarity Protection	Integrated	Integrated
Battery Reverse Polarity Protection	Integrated	Integrated

Technical Data	GW40K-ET-10	GW50K-ET-10
Anti-islanding Protection	Integrated	Integrated
AC Overcurrent Protection	Integrated	Integrated
AC Short Circuit Protection	Integrated	Integrated
AC Overvoltage Protection	Integrated	Integrated
DC Switch	Integrated	Integrated
DC Surge Protection	Type II(Type I+II Optional)	Type II(Type I+II Optional)
AC Surge Protection	Type II	Type II
AFCI	Optional	Optional
Remote Shutdown	Integrated	Integrated
General Data		
Operating Temperature Range (°C)	-35~+60	-35~+60
Relative Humidity	0~95%	0~95%
Max. Operating Altitude (m)	4000	4000
Cooling Method	Smart Fan Cooling	Smart Fan Cooling
User Interface	LED, WLAN+APP	LED, WLAN+APP
Communication with BMS	CAN	CAN
Communication with Meter	RS485	RS485
Communication with Portal	LAN / 4G (Optional)	LAN / 4G (Optional)
Weight (kg)	62	65
Dimension (W×H×D mm)	520×660×260	520×660×260
Noise Emission (dB)	<65	<65
Topology	Non-isolated	Non-isolated
Self-consumption at Night (W)	<15	<15
Ingress Protection Rating	IP66	IP66
DC Connector	MC4 (4~6mm ²)	MC4 (4~6mm ²)
AC Connector	OT	OT
Environmental Category	4K4H	4K4H
Pollution Degree	III	III
Overvoltage Category	DC II / AC III	DC II / AC III
Storage Temperature (°C)	-40~+85	-40~+85

Technical Data	GW40K-ET-10	GW50K-ET-10
The Decisive Voltage Class	Battery: C PV: C AC: C Com: A	Battery: C PV: C AC: C Com: A
Mounting Method	Wall Mounted	Wall Mounted
Active Anti-islanding Method	AFDPF + AQDPF	AFDPF + AQDPF
Type of Electrical Supply System	Three phase Grid	Three phase Grid
Country of Manufacture	China	China
Certification ^{*4}		
Grid Standards	NRS097-2-1, VDE-AR-N 4105, PPDS 2021 Type A2, 50549-1, NBT32004	
Safety Regulation	IEC62109-1&2	
EMC	EN61000-6-1, EN61000-6-2, EN61000-6-3, EN61000-6-4	
<p>*1. Backup function can be only realized with STS Box(Static Transfer Switch Box).</p> <p>*2:In Australia, for most of the PV module, the max. Input power can achieve 2*Pn, Such as the max. input power of GW50K-ET can achieve 100000W</p> <p>*3: Output Voltage Range: phase voltage.</p> <p>*4: Not all certifications & standards listed, check the official website for details.</p>		



Official Website

GoodWe Technologies Co.,Ltd.

 No. 90 Zijin Rd., New District, Suzhou, 215011, China

 www.goodwe.com

 service@goodwe.com



Contact Information